

**KAISAI**

# CATALOGUE

AIR CONDITIONING SYSTEMS

2024

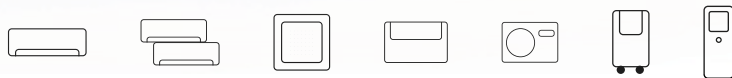
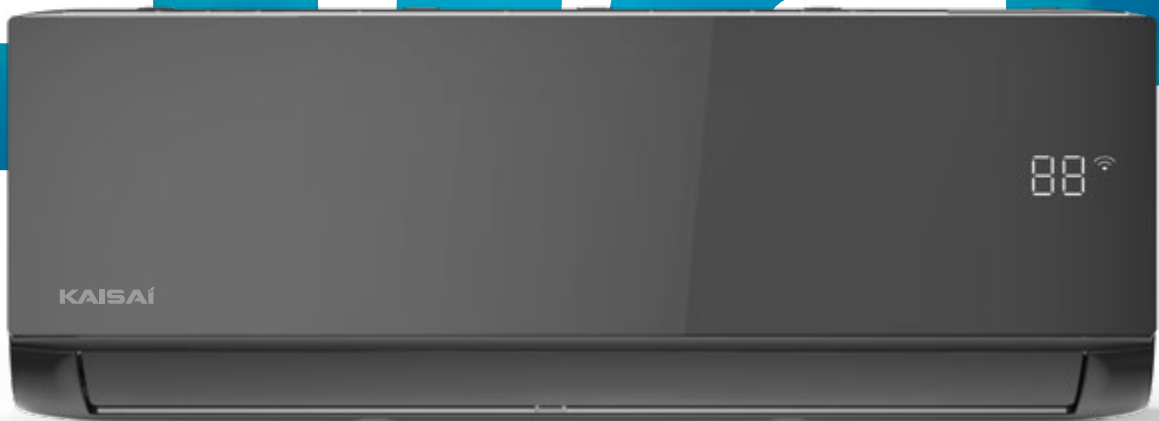

AIR CONDITIONING | VENTILATION | HEATING | PHOTOVOLTAICS

# Take sustainability to a new level

CARE FOR THE ENVIRONMENT WITH US

[kaisai.com](https://kaisai.com) 

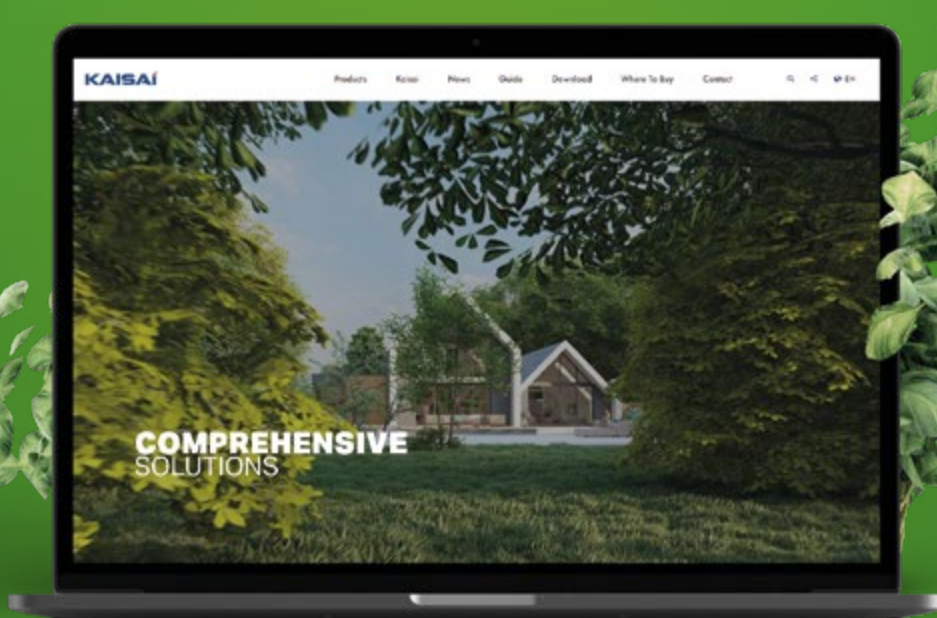

360° PRODUCT  
VIEW



FULL RANGE  
OF DEVICES



CLEAR  
DESIGN



INTUITIVE  
OPERATION



24H ACCESS  
TO CATALOGUES

Making one tonne of paper from recycled paper **saves as much as 17 trees and 1200 litres of water.** By using the kaisai.com website, you have all the catalogues at your fingertips and, most importantly, you contribute to environmental protection. **The earth is our planet – let us care for it together.**

## TABLE OF CONTENTS

---

|                                       |            |
|---------------------------------------|------------|
| <b>About the Kaisai brand</b>         | <b>6</b>   |
| <b>User guide</b>                     | <b>12</b>  |
| How to choose an air conditioner?     | 14         |
| Environmental protection              | 17         |
| Renewable energy sources              | 20         |
| Heat Pumps                            | 22         |
| Photovoltaic modules                  | 24         |
| Heat recovery units                   | 26         |
| The key functionalities               | 28         |
| Modern filters                        | 34         |
| Technologies                          | 36         |
| Overview of functions                 | 40         |
| Product range                         | 48         |
| <b>Wall-mounted air conditioners</b>  | <b>50</b>  |
| Fly wall-mounted air conditioners     | 52         |
| Ice wall-mounted air conditioners     | 56         |
| Geo wall-mounted air conditioners     | 60         |
| ProHeat wall-mounted air conditioners | 64         |
| <b>Multi Split systems</b>            | <b>68</b>  |
| <b>Commercial air conditioners</b>    | <b>74</b>  |
| Floor air conditioners                | 76         |
| Floor and ceiling air conditioners    | 84         |
| Console air conditioners              | 88         |
| Compact cassette air conditioners     | 92         |
| Compact cassette air conditioners     | 96         |
| Slim duct air conditioners            | 100        |
| Condensing units                      | 104        |
| <b>Portable air conditioners</b>      | <b>108</b> |
| <b>Wired and wireless controllers</b> | <b>110</b> |
| <b>Dimensions of the units</b>        | <b>112</b> |
| <b>Accessories</b>                    | <b>122</b> |
| <b>Filters</b>                        | <b>125</b> |
| <b>Contact details</b>                | <b>127</b> |



# WE CARE ABOUT AIR

**We feel responsible for both people and the environment. We take care of air quality and comfort – in the office, at home and in all the rooms where we work and stay every day.**

As much as we care about the air, we care about our business environment both near and far. Following the idea of sustainable development, we have set ourselves priorities based on a pro-environmental approach to business, partnership with the client and care for human resources.

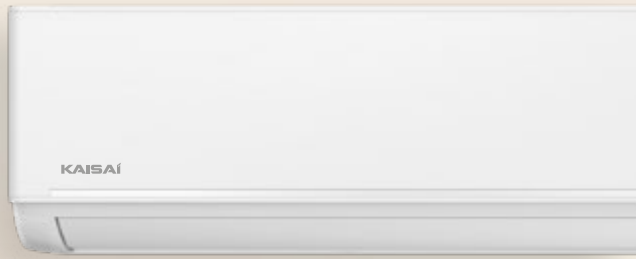

6

# SOLUTIONS

TAILORED TO YOUR NEEDS

GET TO KNOW  
THE RANGE OF  
PRODUCTS  
FROM KAI SAI  
[KAI SAI.COM](https://www.kaisai.com)



WALL-MOUNTED  
AIR CONDITIONERS

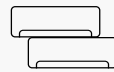

MULTI SPLIT  
SYSTEMS



CASSETTE  
AIR CONDITIONERS



AIR CONDITIONING • VENTILATION • HEATING • PHOTOVOLTAICS

**When you choose Kaisai appliances, you get a high-quality, environmentally friendly product designed for user comfort, yet offered at a reasonable price.**

The Kaisai brand debuted on the Polish market in 2011 and since then it has recorded sales growth every year in Poland and in foreign markets. The latest technological solutions make Kaisai appliances leaders in their class, meeting high expectations in terms of environmental care, energy savings,

quiet operation, safety, user comfort and manufacturer's warranty. Through many years of investment in technology, KAISAI equipment is considered to be some of the most innovative air conditioning solutions for public and residential buildings.

OVER  
**600**  
AUTHORISED SERVICE  
POINTS IN POLAND

OVER  
**500000**  
UNITS SOLD  
IN POLAND

**30**  
TYPES  
OF PRODUCTS



FLOOR AND CEILING  
AIR CONDITIONERS



FLOOR  
AIR CONDITIONERS



CONDENSING  
UNITS



PORTABLE  
AIR CONDITIONERS

# THINK GLOBALLY WORK LOCALLY

As part of the Kaisai International Corporation business platform, following the principle **Think globally – work locally**, the Kaisai brand is present in the following countries:

- Austria
- Belgium
- Belarus
- Bulgaria
- Czech Republic
- Denmark
- Estonia
- Finland
- France
- Greece
- Georgia
- The Netherlands
- Luxembourg
- Lithuania
- Latvia
- North Macedonia
- Malta
- Moldova
- Germany
- Norway
- Poland
- Portugal
- Romania
- Slovakia
- Slovenia
- Switzerland
- Sweden
- Ukraine
- Hungary
- Italy

Kaisai's portfolio includes RAC segment equipment (including wall-mounted air conditioners with Wi-Fi as a standard) and LCAC segment equipment (including Multi Split, ceiling cassette, duct and floor/ceiling air conditioners), as well as portable air conditioners, heat pumps, heat recovery units and air curtains.



# KAISAI

WHEREVER YOU ARE

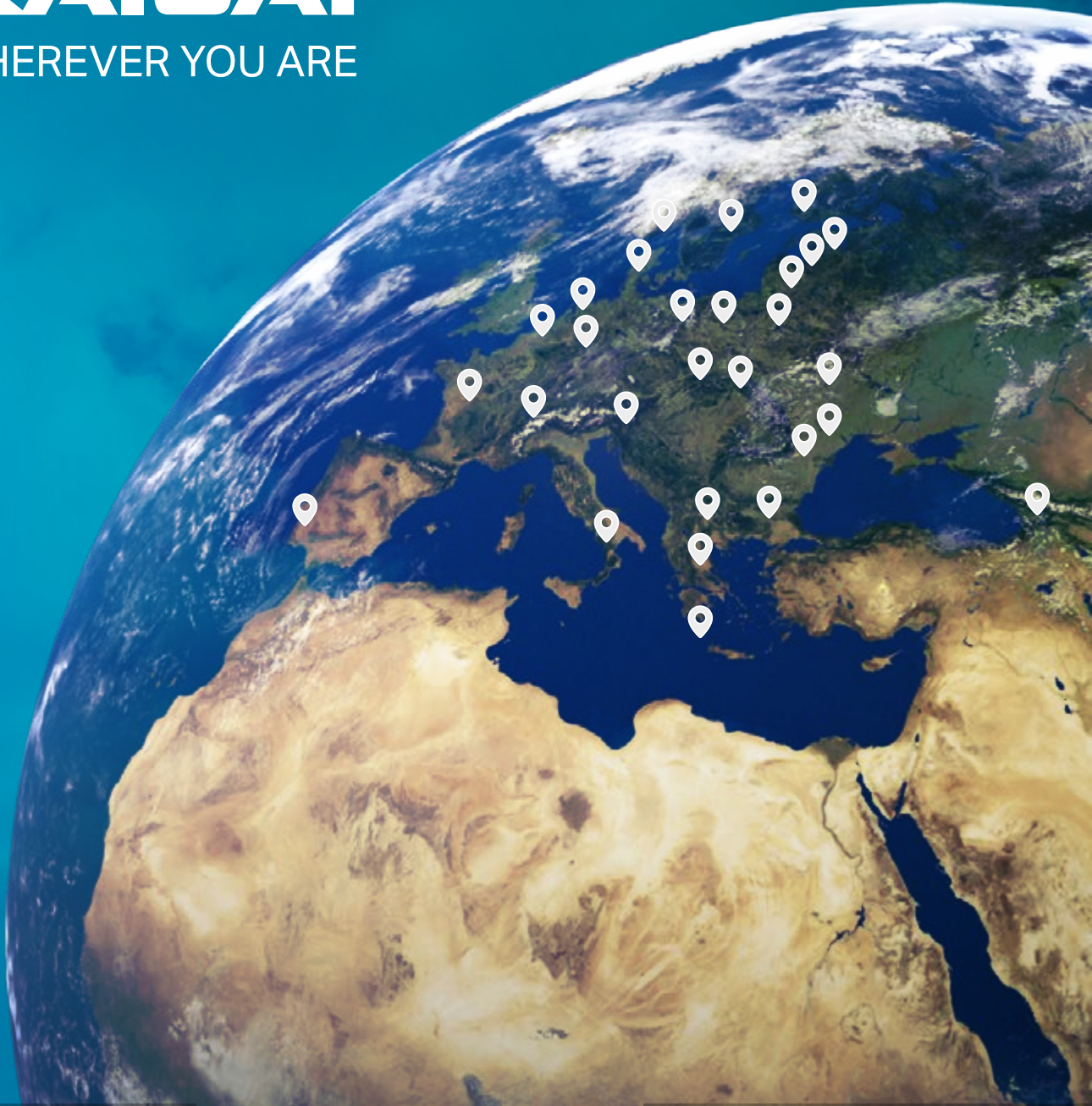

33

COUNTRIES

OVER  
1000

OUTLETS

OVER  
650000

UNITS SOLD  
WORLDWIDE



# Academy of

## KLIMA-THERM GROUP

The Academy of Klima-Therm Group offers training at the highest level, carried out on modern facilities, with the support of an experienced team of trainers – experts in the air conditioning industry.



Academy of Klima-Therm Group is an innovative educational and research project, whose main goal is to constantly raise the knowledge of the industry environment in the field of current trends in air conditioning and ventilation, and the latest product solutions, technology and design. Thanks to the activities of the Academy, customers can be sure of the expertise of our installers: it is a guarantee of the safety and failure-free operation of our equipment.

Kaisai is committed to the highest quality of its products and installations. By being a part of Klima-Therm Group, Kaisai Authorised Service Partners benefit from training opportunities offered by the Academy. The trained installers not only receive theoretical knowledge, but can also acquire practical skills under the guidance of qualified trainers. The Academy has 3 training centres serving clients from all over Poland: in Gdańsk, Warsaw and Katowice.

CE

ISO  
9001:2000

A++  
(EU)626/2011

A+  
(EU)626/2011

ATEST  
PZH

Kaisai products meet stringent requirements related to safety of use, health protection and environmental protection, and as a result have obtained various designations and certifications. The refrigerants used are approved by the National Institute of Public Health.



# Develop WITH KLIMA-THERM ACADEMY



PRODUCT  
TRAINING



AUTHORISATION  
TRAINING



TECHNICAL  
TRAINING



EQUIPMENT  
TESTS



# User guide

**With the wide range of air conditioning systems on offer today, it is important to consider which units will be suitable for a particular facility before making a purchase.**

Different types of air conditioners will be suitable for cooling and heating purposes in a house, while completely different types will be suitable for an office building or shopping mall. The correct choice of air conditioner type and performance is a prerequisite for satisfaction. It is best to entrust the selection of equipment in terms of efficiency to specialists with the relevant knowledge and experience.

# How to choose

## KAISAI AIR CONDITIONING?

The correct choice of an air conditioner's capacity for an apartment is the basis for efficient air conditioning at home or in the workplace. A unit with not enough power will not cool the room air to the required temperature. And equipment with more power than needed is more expensive to buy and operate. So how do I choose an air conditioner for my existing conditions?

From March to September, days are longer and temperatures are higher. Especially between June and August, there are periods of several weeks of hot weather, which can cause discomfort when staying indoors. It's worth thinking about this beforehand, ensuring the ideal, comfortable air temperature regardless of the time of year or day.



USE UP TO  
4 TIMES **LESS**  
**ELECTRICITY**

Air conditioning was previously associated mainly with office space. It is now within the financial reach of individual users. Additionally, thanks to the heating function available in modern units, air conditioners can also serve as an additional source of heat during colder periods. Air conditioning is an efficient and economical alternative to fans and electric heaters – it uses up to 4 times less electricity.



EFFICIENCY



HEALTH



SAFETY



EACH SPLIT AIR CONDITIONER  
CONSISTS OF **TWO COMPONENTS:**

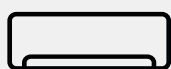

indoor unit



outdoor unit

The former one is installed inside and the latter – outside of the building.



## COMFORT AND **HEALTH**

Air conditioning is available to everyone. It allows you to freely control the temperature in your home, flat, office or small retail outlet; it replaces or complements central heating. But the advantages of installing air conditioning do not end there. Installing it proves to be an excellent way to ensure the health of all users.

Modern air conditioners eliminate bacteria and fungi from the air, preventing the diseases they cause, and special filters improve overall air quality. Air conditioning is also a good solution for maintaining the correct air parameters when the outside air is heavily polluted, e.g. with smog.



## **COST** OF OPERATION

In principle, domestic air conditioning differs in power consumption from industrial air conditioning, which is more demanding in this respect. The 2.6 kW unit uses less than 1 kW of electricity per hour of operation, which translates to a cost of around 50 groszys.\* There are a number of general recommendations and indicators that allow the user to initially determine the required power of the appliance himself. The most important parameter is the cubic capacity of the air-conditioned room. It is assumed that for standard rooms with a height of approximately 3 m, a cooling power of 40 W/m<sup>3</sup>, i.e. 120 W per m<sup>2</sup> area is required. This means that for a room of 21 m<sup>2</sup> even the smallest air conditioner with an output of 2.6 kW may be sufficient.

\* example cost, calculated for Warsaw (Poland), for a private user.

## HOW DOES AN **AIR CONDITIONER** WORK?

The principle of the air conditioner's operation is based on the physical properties of the refrigerant, which in the case of Kaisai units is the environmentally friendly R32 refrigerant. Depending on the operating mode of the air conditioner, the refrigerant condenses or evaporates in the indoor unit – giving up or drawing heat from the environment, respectively. In this way, the air in the room is heated or cooled and, thanks to a system of filters, also purified.

**The unit does not blow additional air from the outside, but only cools the inside. This makes it possible to care for the health of users, especially during periods of smog.**



# High energy class

## SAVE MONEY ALL YEAR LONG

# A+++

The more economical the appliance is, the higher its energy class. When buying an air conditioner, it is therefore worth paying attention to ensure that the energy class of the air conditioner is at least A-rated.

When the air conditioner is running, remember to close the windows in the air-conditioned room, thus contributing to savings in energy bills. Do not set the room temperature too low on the remote control, as such a setting can result in increased running costs, among other things.



## WHAT IS GWP?

**Global warming potential.** Is a figure expressing the potential impact that a refrigerant could have on global warming if released into the atmosphere. It is a relative value comparing the impact of 1 kg of refrigerant with the impact of 1 kg of CO<sub>2</sub> over a period of 100 years.

## WHAT IS ODP?

**Ozone Depletion Potential** is an indicator, which refers to the harmful effects that chemicals cause to the ozone layer. This is a value comparing the impact of a given refrigerant with the equivalent mass of Freon R11. ODP for Freon R11 is defined as 1, while a modern refrigerant R32 has a potential defined as 0.

# Environmentally friendly R32 refrigerant

THROUGHOUT THE KAISAI RANGE



Attention to environmental protection and energy efficiency of the equipment are among the basic principles of the Kaisai brand. The entire range of Kaisai air conditioners now uses the latest environmentally friendly refrigerant R32.

It is more efficient than previously used, so the air conditioning system requires less of it, and has a much better environmental impact factor. It is a modern solution taking into account both environmental needs and economy of use.



## ENVIRONMENTALLY FRIENDLY

R32 has one of the lowest GWP values available on the market – 675, it also does not cause damage to the ozone layer thanks to the ODP value equal to 0.



## ECONOMICAL

Compared to R410A, R32 is more energy-efficient, that is why less refrigerant is required by the cooling system and equipment efficiency is increased by up to 10%.



## SAFE

R32 has low toxicity and is almost non-flammable – it does not pose a threat to life and health even in case of system leaks.

# Safe refrigerant R290

## IN MOBILE AIR CONDITIONERS

The refrigerant R290 is known by the common name propane – a colourless, odourless organic compound belonging to the group of saturated hydrocarbons naturally occurring in natural gas deposits.

Propane-based equipment has been operating successfully in various EU countries for many years. Its popularity continues to grow due to its low environmental impact while maintaining very good thermodynamic properties.

**R290 has low sensitivity to moisture and is non-corrosive, making it suitable for use in refrigeration systems equipped with both hermetic and semi-hermetic compressor units.**



### ZERO ODP

R290 has a zero ODP, meaning no negative impact on the ozone layer, and an extremely low GWP, which indicates its impact on global warming. Propane is a flammable gas and its flammability limit is 2.1% by volume in air. This means that with 230 g of R290 refrigerant in Kaisai appliances and thanks to special fire protection, it is also safe for use in enclosed spaces.



# Renewable

## ENERGY SOURCES

**Renewable energy sources (RES) are based on natural resources, the extraction of which ensures not only zero-emission energy production but also a wide range of possibilities for its use.**

Due to relatively easy access to technology and the possibility for it to be used by companies and individual households, the most popular solutions are the units which obtain energy from the air and the sun. Kaisai's product range provides state-of-the-art RES solutions that include air-to-water heat pumps, heat recovery units, and photovoltaic modules and inverters.

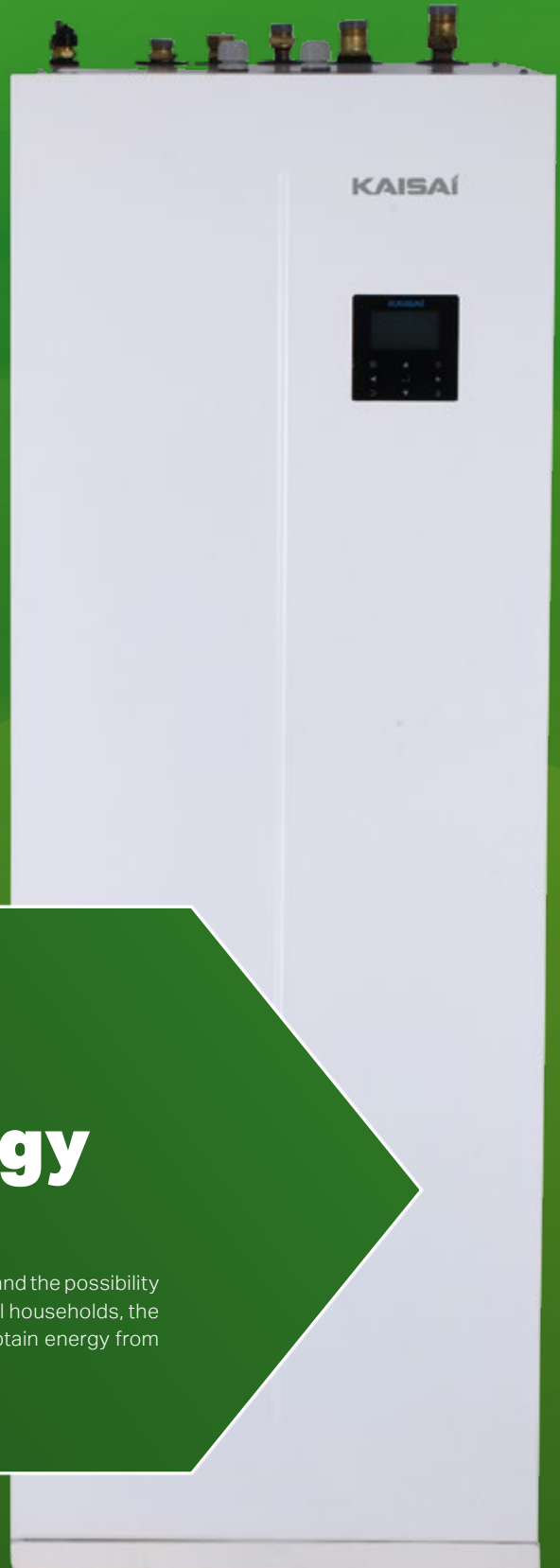

# Bet on green energy

## ALL YEAR

Due to relatively easy access to technology and the possibility for it to be used by companies and individual households, the most popular solutions are the units that obtain energy from the air and the sun.

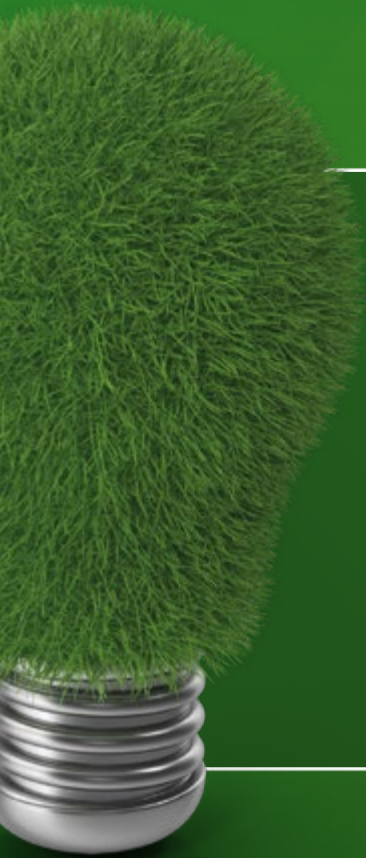

# Our offer includes:

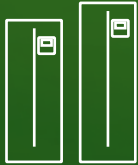

## HEAT PUMPS

Thanks to the cutting-edge technology, air-water KAISAI heat pumps operate in a very wide range of outside temperatures and achieve high temperatures in the heating system or for domestic hot water.



## PHOTOVOLTAIC MODULES

KAISAI photovoltaic modules with special cell design allow the electrode resistance to be decreased and a lower current to be achieved, thus improving the module efficiency.



## PHOTOVOLTAIC INVERTERS

KAISAI inverters are a series of devices with the highest technical parameters, ensuring efficient operation in any conditions. Flexible installation, and a compact and lightweight aesthetic design enable general and flexible use in domestic and commercial projects.



## HEAT RECOVERY UNITS

Kaisai heat recovery units are high-efficiency devices for mechanical ventilation of homes, flats, offices and shops, designed and manufactured in accordance with the latest technological trends.



**The full range of products based on renewable energy sources is available on our website**

**kaisai.com**

# Environmentally friendly in every way

CARE FOR THE ENVIRONMENT WITH US



**The heat pump draws free energy from the air and uses it to heat and cool the building, or prepare domestic hot water. It is a cheap, ecological and reliable heat source, which can be used by anyone.**

Thanks to cutting-edge technology, Kaisai heat pumps operate in a wide range of outside temperatures and achieve the high temperature parameters of the heating system or domestic hot water. No emission of harmful substances into the environment, operational safety, and maintenance-free make the Kaisai heat pumps an ideal solution for everyone who builds a house as well as replaces or retrofits the current heat source. The Kaisai heat pumps can be used in single-family, multifamily, and commercial buildings.



# Heat pumps

## ECOLOGIC ENERGY SOURCE

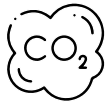

### REDUCED CO<sub>2</sub> EMISSIONS

Heat pumps are an ideal alternative to gas and coal-fired boilers, helping to reduce CO<sub>2</sub> emissions into the atmosphere. While operating at the time selected by the user, the devices do not produce smoke, ash or any other substances harmful to the environment.

The full range of products based on renewable energy sources is available on our website

[kaisai.com](https://kaisai.com)



### COMFORT ALL YEAR LONG

A heat pump transfers heat from the air to the water, heating it up. Thanks to its automation, the heat pump ensures user comfort and simple operation. The convenient indoor temperature and the desired domestic water parameters are set using an intuitive controller. The user does not have to worry about „firing up the boiler“, as the unit will automatically maintain a comfortable level of temperature throughout the year.



### LOW OPERATING COSTS

Heat pumps make a significant contribution to reducing the house's operating costs. The cost of heating and domestic hot water can be reduced by up to four times with a heat pump. The use of a heat pump also reduces system maintenance costs, e.g., as chimney inspections are not needed.

## Use the heat from the air

### TO HEAT YOUR HOME

Heat pumps are one of the environmentally friendly energy sources, because instead of coal, gas or oil, they use the potential of the air, using refrigerants that have a significantly lower impact on the environment than non-renewable energy sources. The electric power supply also allows the use of home photovoltaics in the so-called passive house system (i.e. without drawing energy from outside).



# Modules and inverters

EFFICIENT AND QUIET OPERATION IN ALL CONDITIONS

**Photovoltaics is the conversion of sunlight into electricity, taking place using modules made up of cells connected in series in a frame. It is a stable and inexhaustible source of green energy that does not pollute the environment.**

A photovoltaic installation enables the creation of a low- or zero-energy building. By producing its own electricity and storing it in the grid, a household is able to meet its needs for domestic hot water, powering household appliances, heating and recuperation.

KAISAI photovoltaic modules with special cell design allow the electrode resistance to be decreased and a lower current to be achieved, thus improving the module efficiency. This reduces losses caused by partial shading and cell wear, while increasing the solar energy conversion capacity.



## Inverters

Kaisai inverters are modern devices working on proven quality microprocessor chips. They ensure efficient, high-performance and trouble-free operation in the installation and enable monitoring of all parameters of the photovoltaic system, allowing the optimal amount of energy to be extracted.

### OPERATION PRINCIPLE

The solar inverter converts the direct current produced by the photovoltaic panels into alternating current with parameters compatible with those of the power grid. It also monitors the performance of the home solar power plant and automatically tracks the power point to capture the maximum

amount of energy from the solar panel array. At dusk, when the intensity of sunlight is too low to generate electricity, the inverter automatically switches off and restarts during the day when the input voltage reaches its initial value.



# Photovoltaic modules

FOR YOUR HOME AND OFFICE

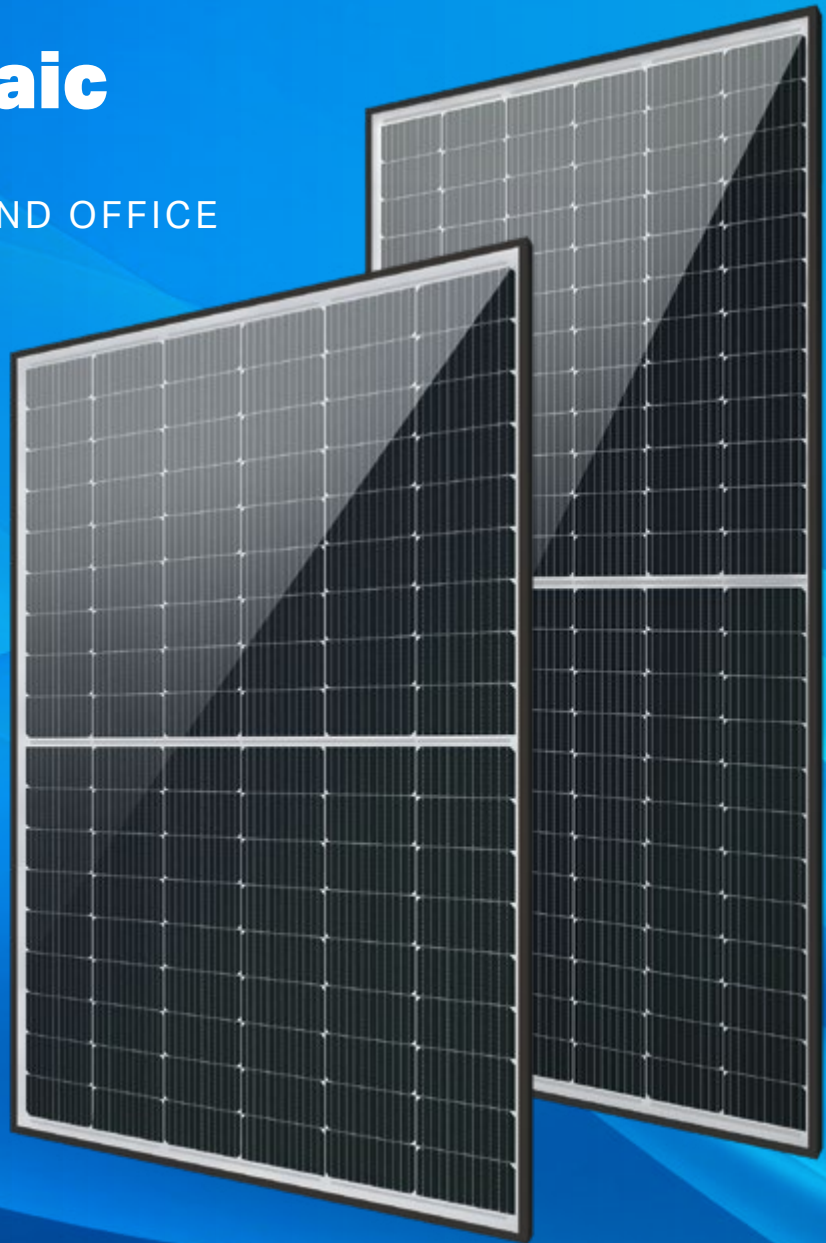

Full range of products based on renewable energy sources available on our website

**kaisai.com**



HIGHEST WATER RESISTANCE CLASS THE JUNCTION BOX



RESISTANCE TO HARSH CONDITIONS



RESISTANCE TO WIND AND SNOW LOAD



# Heat recovery units

HIGHEST AIR COMFORT

Recuperation is a type of mechanical ventilation supplemented with heat recovery. A heat recovery unit makes it possible to control the movement of the air supplied to the room and to recover heat from the polluted air coming from inside the house. Additionally, the filters installed in the unit clean the air of pollutants, allergens and smog.

Kaisai heat recovery air handling units are high-efficiency ventilation units with heat recovery for mechanical ventilation of homes, offices and stores. During their operation, they exchange the exhaust air from the interior with the air drawn from the outside, purified by means of a special high-performance class F7 filter. The counter-current heat recovery exchanger prevents heat loss, recovering up to 92.5% of the energy during the winter. The recovered heat is transferred to the clean air entering the rooms.

The full range of products based on renewable energy sources is available on our website

[kaisai.com](https://kaisai.com)

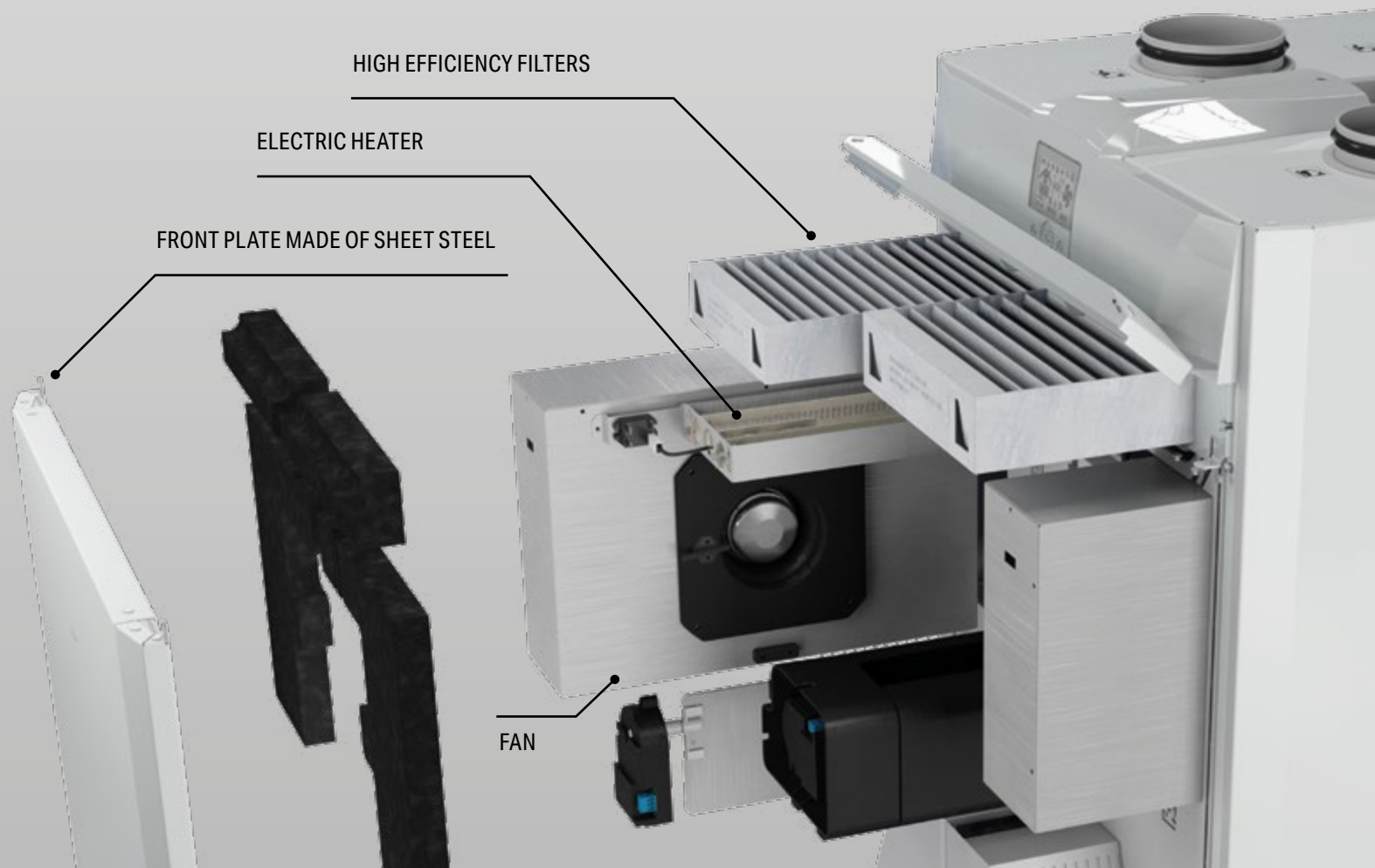

# Energy efficiency

## CLASS OF KAISAI APPLIANCES

|                        | <b>SEER<br/>(Cooling mode)</b> | <b>SCOP<br/>(Heating mode)</b> |
|------------------------|--------------------------------|--------------------------------|
| <b>A<sup>+++</sup></b> | SEER ≥ 8,50                    | SCOP ≥ 5,10                    |
| <b>A<sup>++</sup></b>  | 6,10 ≤ SEER < 8,50             | 4,60 ≤ SCOP < 5,10             |
| <b>A<sup>+</sup></b>   | 5,60 ≤ SEER < 6,10             | 4,00 ≤ SCOP < 4,60             |
| <b>A</b>               | 5,10 ≤ SEER < 5,60             | 3,40 ≤ SCOP < 4,00             |
| <b>B</b>               | 4,60 ≤ SEER < 5,10             | 3,10 ≤ SCOP < 3,40             |
| <b>C</b>               | 4,10 ≤ SEER < 4,60             | 2,80 ≤ SCOP < 3,10             |
| <b>D</b>               | 3,60 ≤ SEER < 4,10             | 2,50 ≤ SCOP < 2,80             |
| <b>E</b>               | 3,10 ≤ SEER < 3,60             | 2,20 ≤ SCOP < 2,50             |
| <b>F</b>               | 2,60 ≤ SEER < 3,10             | 1,90 ≤ SCOP < 2,20             |
| <b>G</b>               | SEER < 2,60                    | SCOP < 1,90                    |

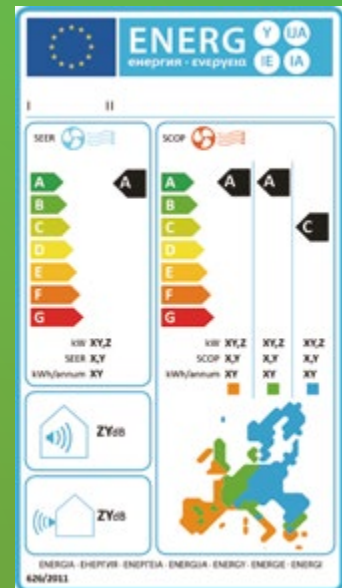

CURRENT ENERGY LABEL

Applicable from 1 January 2013 Air conditioners up to 12 kW

Energy labels are placed on every domestic electrical appliance sold in the European Union. This is regulated by a special EU Directive 2010/30/EU. Labels inform the user about the quality of the product, taking into account, in particular, its energy efficiency. Before purchasing, the label allows everyone to compare which device will be the cheapest in terms of operation. The energy efficiency rating, also known as energy class, is indicated by letters: for air conditioners a scale from G (lowest) to A++ (highest) has been established.

We also use seasonal energy efficiency factors to evaluate energy savings: SEER for cooling and SCOP for heating. These ratios determine the ratio between the cooling/heating power achieved by the air conditioner and the electrical power drawn by the unit from the mains for an entire season. Units with SEER=6 and SCOP=4 (A++ class) can generate 6 kW of cooling energy or 4 kW of heating energy from one kW of electricity on average per season and can be up to 4 times cheaper to run than electric fans and heaters.

10-grade energy efficiency scale (from A+++ to G)

Power consumption efficiency for cooling and heating

Performance rating based on a multi-feature calculation, corresponding to the actual power consumption of the unit during operation

Sound power level

Data for 3 seasons (temperate – required, warm and cool – optional)

# Modern functions of units

TECHNOLOGY FOR YOU



Advanced features of Kaisai appliances ensure high comfort, convenience and safety of use as well as economic and efficient operation. Using modern purification functions means you always have clean air in your home – free of viruses, allergens and smog.

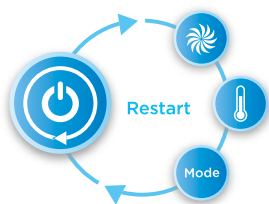

### AUTOMATIC **RESTART**

For units equipped with the auto restart function, when power is interrupted the air conditioner remembers the last settings and automatically resets them when power is restored.

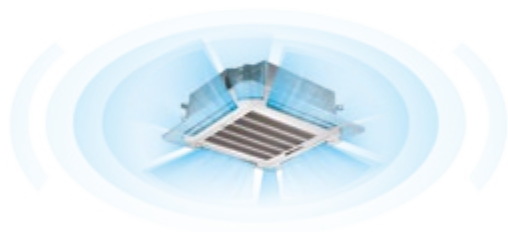

### **360°** AIR SUPPLY

The cassette air conditioners are equipped with additional supply slots in the panel. Thanks to this design, the 360° unit can provide even better air distribution in the conditioned room.



### TEMPERATURE **SENSOR**

The temperature sensor is built into the remote control. In this way, temperature measurements are taken at the user's location, while the air conditioner's operation is adjusted to the actual conditions in the room.



### OPERATION AT **LOW OUTSIDE TEMPERATURES**

Thanks to a specially designed control board, the air conditioner can operate in the cooling function even with outdoor temperatures as low as -25°C.

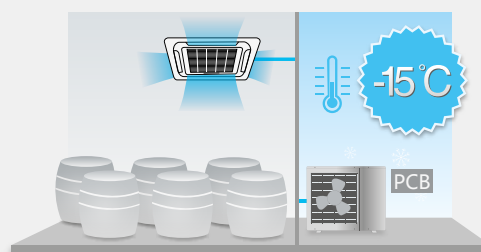

### **3D** AIR SUPPLY

The horizontal and vertical blinds of the air conditioner are controlled automatically, in order to ensure uniform temperature distribution in the room and optimal air circulation.

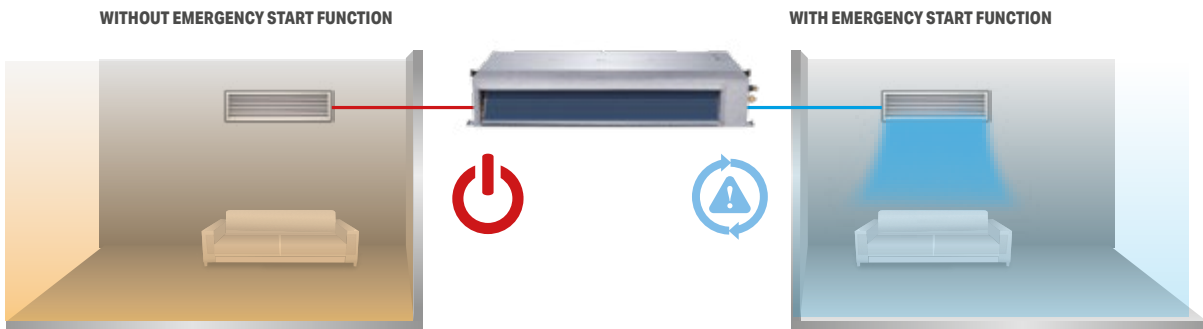

## EMERGENCY USE

The emergency use function of the air conditioner allows the unit to operate even if one of the sensors has failed. With this solution, the operation of the air conditioner is not interrupted and it can be used until the fault is rectified.



## FRESH AIR

Outside air can be supplied through a connection duct to the air conditioner, thus improving the air quality in the room.

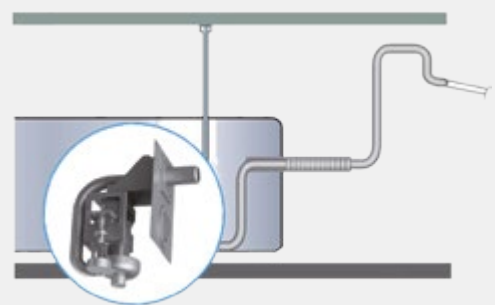

## BUILT-IN CONDENSATE PUMP

Thanks to the integrated condensate pump, it is possible to remove condensate up to a height of 1000 mm.

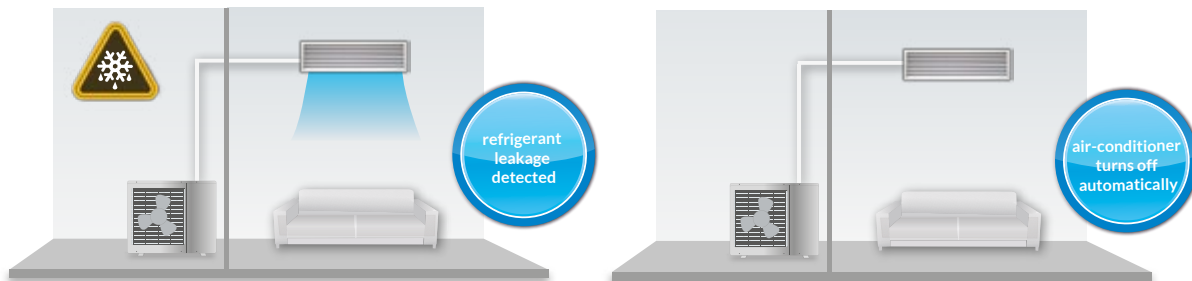

**REFRIGERANT LEAKAGE INDICATION**

The air conditioner has a refrigerant leakage indication function. If the unit records a leakage, the EC message will appear on the display of the indoor unit and the air conditioner will automatically switch off. This function additionally protects the compressor from being damaged.

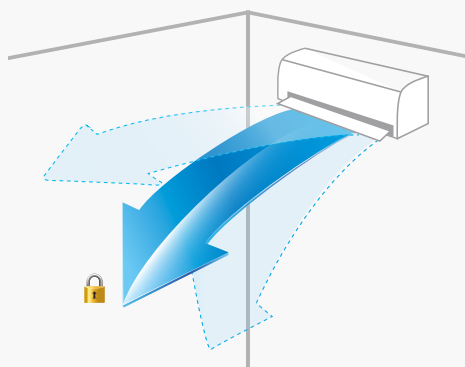

**BLINDS SETTINGS MEMORY**

Thanks to the function of saving the blinds settings, the air conditioner keeps the last settings after it is switched off and restores them when restarted.





**CENTRAL CONTROLLER**

Option to connect a central controller, controlling up to 64 indoor units.

## TWIN SYSTEM

The TWIN simultaneous system makes it possible to connect two indoor units of the same type and capacity to a single unit (outdoor unit). This solution improves air distribution in air-conditioned rooms and saves installation space by installing only one outdoor unit.

This system is ideal for air-conditioning large spaces such as conference and banquet halls, open-plan offices, restaurants and other service and commercial buildings. In a twin system, one indoor unit must be set as master and the other as slave. Only the master unit can accept the control signal from the remote control, the slave unit only performs the settings of the master unit.

| Outdoor unit  | Indoor unit                            | Branch pipe |
|---|--|-------------|
| <br>KOD30U-36HFN(J)32X | 2 x KUE-18HRG32X<br>2 x KCA4U-18HRG32X | UTP-SX236A  |
|   | 2 x KTI-18HWG32X                       |             |
| <br>KOE30U-48HFN32X    | 2 x KCD-24HRG32X                       | UTP-SX254A  |
|   | 2 x KUE-24HRG32X                       |             |
|   | 2 x KTI-24HWG32X                       |             |

For the new KCA4U compact cassette units, it is possible to install double, triple and quadruple simultaneous systems. Technical details can be found in the service manual for cassette air conditioners.

### INSTALLATION DIAGRAM FOR SIMULTANEOUS TWIN SYSTEM

To avoid system malfunction, use Kaisai brand triple connectors. The indoor units should be installed in equal numbers on both sides of the U-type triple connector.

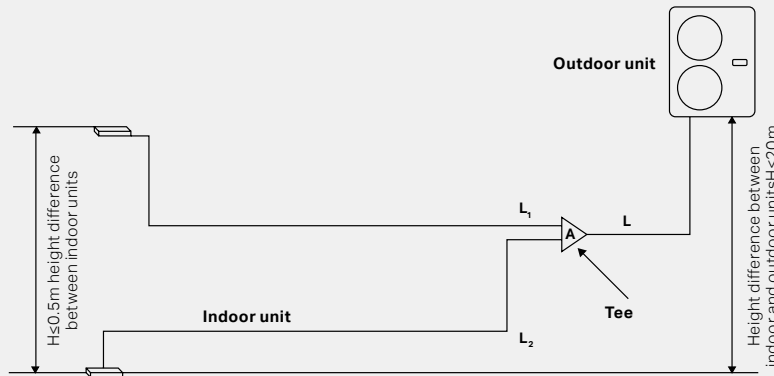

|                     | Acceptable value   | Installation               |
|---------------------|--|----------------------------|
| Installation length | Total installation length (active)                         | 18K+18K 30m<br>24K+24K 50m |
|                     | Maximum branch length                                      | 15m                        |
|                     | Maximum branch length difference                           | 10m                        |
| Height difference   | Maximum height difference between indoor and outdoor units | 20m H1                     |
|                     | Maximum height difference between indoor units             | 0,5m H2                    |





### FIXED HEATING 8°C

The function of maintaining a constant temperature of 8°C in heating mode is a particularly useful solution for holiday homes and detached houses.

It keeps the air conditioner at a constant temperature of up to 8°C; it prevents rooms from cooling down and pipes from freezing. This counteracts the build-up of moisture and thus the growth of micro-organisms and

fungi. Air conditioners with this option are a more efficient solution than the commonly used thermostatically controlled electric heaters.

This is the hallmark of Kaisai brand home air conditioners. Combined with Smart AC and the ability to set the temperature remotely, this makes our products ideal for users who are often away from home.

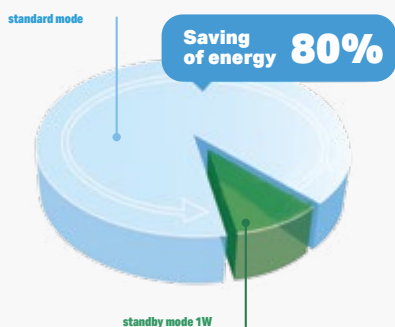

### STANDBY MODE

In standby mode, power is disconnected from unused electronic components, reducing power consumption to 1 watt compared to standard devices, which consume an average of 5 watt in this mode, achieving savings of approximately 80%.

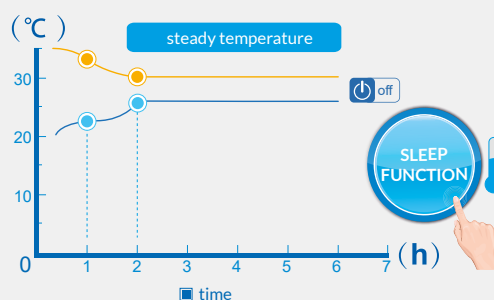

### SLEEP FUNCTION

Activating the sleep function causes the unit to raise the temperature set in cooling mode (lower in heating mode) by 1°C per hour within two hours. During this time the fan runs at low speed. After 5 hours, the air conditioner switches off. Slow, hardly noticeable temperature changes and automatic switching off guarantee comfort and energy savings.

# For the sake of health

AND COMFORT OF USERS

Modern filters used in Kaisai brand products guarantee clean and fresh air in the air-conditioned room. They capture very small dust particles, bacteria, fungi and germs, leaving healthy and clean air.

## **SELF-CLEANING** EXCHANGER

To ensure the highest standards of hygiene and comfort, Kaisai brand appliances use the latest self-cleaning technology for the internal exchanger. The air conditioner enters cleaning mode after it completes its operation. It removes any moisture that may have accumulated in the unit, which prevents the growth of micro-organisms and fungi.

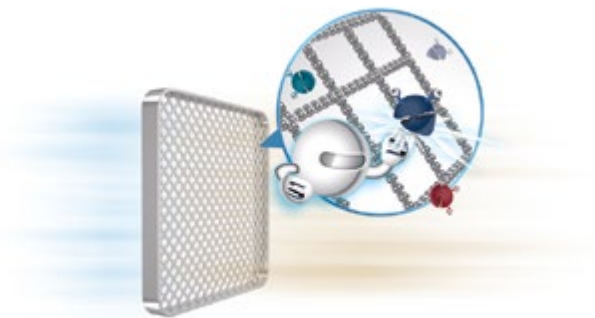

### SILVER ION FILTER

The silver ion filter is responsible for destroying bacteria and preventing the growth of micro-organisms such as viruses and fungi. The internal structure of the silver ions destroys micro-organisms.

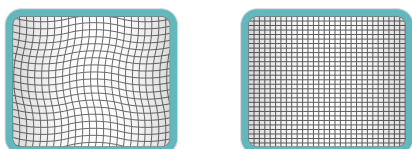

### VITAMIN C FILTER

The filter emits vitamin C, which has a positive effect on the skin by protecting it from the sun's rays. As an active antioxidant, vitamin C has a nourishing effect, stimulates collagen production and reduces stress.

### HIGH DENSITY FILTER

The use of high-density filters significantly increases the efficiency of dirt retention – by up to 50%.

### 3M FILTER

Thanks to its unique design, the filter captures dust particles and other harmful substances from the air, which can cause many respiratory diseases.

**NEW**

### BIOHEPA FILTER

The air purification function is further supported by the Bio HEPA filter, which effectively traps 99% of dust particles and bacteria measuring 0.3 µm and up to 95% of particles from 0.1 to 0.3 µm, including fungal cells and some viruses.

**NEW**

### COLD CATALYTIC FILTER

The cold-catalytic filter eliminates chemicals such as carbon monoxide, hydrogen sulphide, ammonia, benzene and formaldehydes.

# Modern technologies

## USED IN KAISAI APPLIANCES

Kaisai appliances are characterised by high quality workmanship and the use of modern technology – all for the user's convenience. Efficient and comfortable air conditioning is now available to everyone.



heating [°C]

**-25 ÷ 30**

cooling [°C]

**-15 ÷ 50**

### TOTAL INSTALLATION LENGTH

Kaisai split units have the option of installing the outdoor and indoor units far apart – up to 75 m in total length and up to 30 m in vertical height. This makes it much simpler to lay out appliances even in older buildings. You do not have to adapt your home design to air conditioning – we adapt it for you.

### OPERATING TEMPERATURE

By using modern technology and the new refrigerant R32, Kaisai air conditioners can operate in a wide range of outdoor temperatures: from -15°C to 50°C in cooling mode and from -25°C to 30°C in heating mode. They can fulfil their purpose all year round, guaranteeing users can enjoy the comfort of cool in summer and additional heating in winter.

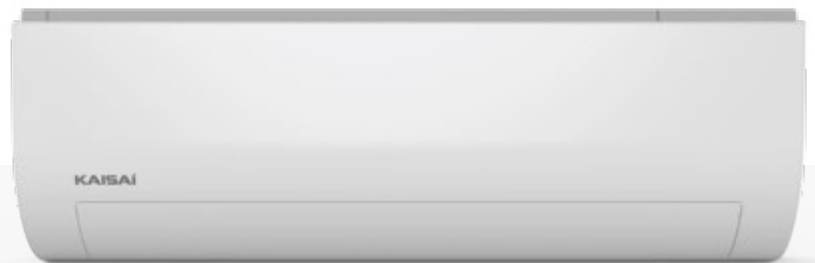

### DIMENSIONS AND DESIGN

We make every effort to ensure that Kaisai units follow the latest design trends: we want the air conditioner to please the eye with its tasteful form and fit in with modern interior design trends. In addition, when designing indoor cassette and duct units, we are mindful of the space they occupy. Thanks to the optimum size of the units, the suspended ceiling does not require much technical space and thus leaves more usable space.



## INVERTER TECHNOLOGY

The inverter technology in the Kaisai's units reduces power consumption, which is related to the reduction of room cooling and heating costs. Its use translates to the quiet operation of the unit and faster achievement of the desired temperature.

By using durable and high-pressure resistant materials, the compressor in Kaisai's heat pumps is extremely reliable. In addition, it has a high-efficiency motor with a wide voltage range, which is why it can operate in extreme conditions in 24-hour mode and reach temperatures of up to 60°C (230V/50Hz).

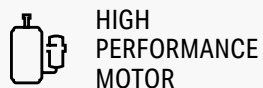

# Commercial air conditioners

EFFECTIVE COOLING AND REAL COMFORT



CHANGING  
OPERATING MODE,  
TEMPERATURE, AND  
FAN SPEED



PREVIEW OF DEVICE  
OPERATION  
INFORMATION



MOBILE APP FOR  
ADROID AND IOS

**SMART PORT IS A WI-FI  
MODULE FOR COMMERCIAL  
KAISAI AIR CONDITIONERS**

Wi-Fi control can now be used not only for wall-mounted air conditioners, but also for other models of Kaisai air conditioners.

# Wall-mounted air conditioners

ELEGANT APPEARANCE AND COMFORT OF USE

Kaisai products incorporate several features improving the comfort of use; for example, new control options have been added so that managing air conditioning has never been so convenient and simple.

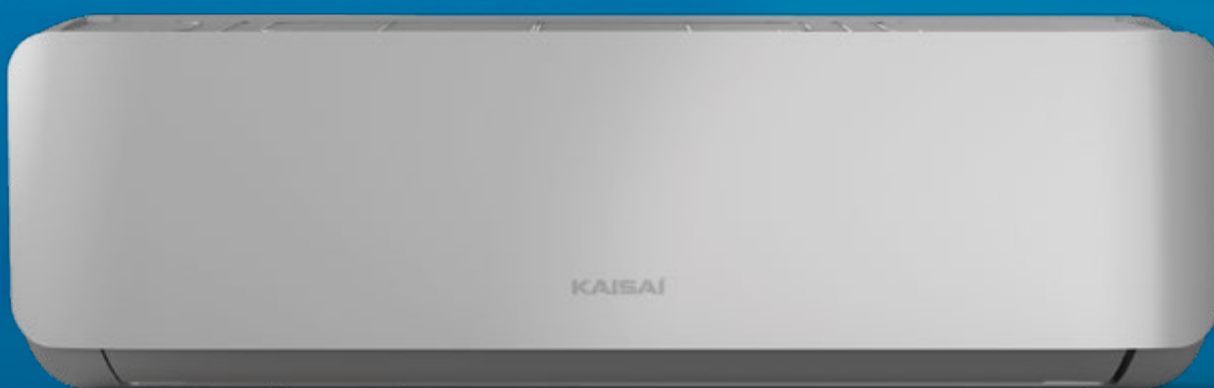

## SMART AC

Smart AC is a Wi-Fi module added as standard to all Kaisai wall air conditioner models. Thanks to its use, the user can control the device via an application installed on a tablet or smartphone, even when away from home or the office.

Using the Wi-Fi function, the user is able to switch the unit on or off, change the temperature and selected operating functions from any place in the world with Internet access. Wi-Fi control allows you to save electricity and increase the comfort of air conditioning by controlling the temperature in your home or office from any location.



## NETHOME PLUS APPLICATION

Reliable operation of the Smart AC system is ensured by the Nethome Plus app installed on a tablet or smartphone. **Download the app by scanning the QR code**

# Enable the innovative capabilities of your unit

DISCOVER ALL KAISAI FUNCTIONS



**Kaisai air conditioners are equipped with a number of modern features that, in addition to providing the right temperature, allow you to enjoy the comfort of breathing clean air every day.**

Advanced features of Kaisai appliances are also convenience and safety of use, as well as economical and efficient operation.



## COMFORTS

**TIMER**

The timer gives you the option to set the time for automatic switching on and off of the air conditioner.

**MONO AND MULTI**

The indoor unit is versatile and can be used in single (mono-split) and multiple (multi-split) arrangements.

**CENTRAL CONTROLLER**

Option to connect a central controller, controlling up to 64 indoor units.

**SIMPLE INSTALLATION**

The air conditioner is designed to be easy to install and require no extra steps.

**MULTI-DIRECTIONAL CASTORS**

Thanks to the integrated castors, relocating the air conditioner is easy.

**DOUBLE-SIDED INSTALLATION**

Refrigerant supply and condensate drainage pipes can be connected on both sides of the indoor unit for easy installation and adaptation to the room layout.

**MFB MODULE**

Expansion module that allows the connection of a wired controller, central controller, BMS gateway, external ON/OFF signal and output of an alarm signal.

**AUTOMATIC BLINDS (SWING)**

The automatic operation of horizontal blinds significantly improves the air distribution in the room.

**PERSONALISED REMOTE CONTROL**

Option of changing the factory settings of the remote control in order to adapt it to the current needs of the user.

**BLINDS SETTINGS MEMORY**

After each shutdown, the air conditioner remembers the last blinds settings and restores them when restarted.

**ON-OFF PORT**

The air conditioner has a port that allows it to be switched on and off remotely (using a potential-free signal).

**WI-FI CONTROL**

The Wi-Fi module allows you to control the air conditioner using your phone or tablet from anywhere in the world.

**TWIN COMBINATION**

Two identical indoor units operate simultaneously, connected to a single outdoor unit.

**BUILT-IN CONDENSATE PUMP**

Thanks to the integrated pump, it is possible to remove condensate up to a height of 1000 mm.

**COMPACT DIMENSIONS**

Well-planned components make the air conditioner small while retaining full performance parameters.

**LARGE INSTALLATION RANGE**

The indoor and outdoor units can be up to 50 m apart in total installation length and up to 25 m apart in vertical installation height.

**VERY LARGE INSTALLATION RANGE**

Indoor and outdoor units can be spaced up to 75 m apart in total installation length and up to 30 m apart in vertical installation height.

# Features that help you look after your health

## HEALTH



### IONISATION

The ions emitted by the air conditioner break down particles of dust mites, mould, bacteria and viruses, eliminating them from the environment, and humidify the air, which has a positive effect on the skin and gives a pleasant feeling of freshness.



### BIOHEPA FILTER

The air purification function is supported by a Bio HEPA filter that effectively traps 99% of dust, dirt and bacteria particles of 0.3  $\mu\text{m}$  and up to 95% of particles from 0.1 to 0.3  $\mu\text{m}$ , including fungal cells and some viruses.



### VITAMIN C FILTER

The filter emits vitamin C into the room, which is absorbed by the skin. The vitamin increases skin firmness, protects against harmful UV rays and also reduces stress.



### HIGH DENSITY FILTER

The use of a high-density filter improves the efficiency of the retention of contaminants, including dust and particles. Not only does it protect the appliance but also takes care of the air quality.



### SILVER ION FILTER

This filter contributes to the elimination of bacteria and other harmful micro-organisms through the use of active silver ions. It ensures a high standard of air hygiene.



### FRESH AIR

Fresh outside air is supplied to the unit via a connecting pipe. This significantly improves the air quality in the room.



### 3M FILTER

This filter, thanks to its unique design, more efficiently captures dust and harmful allergic substances from the air, which cause respiratory tract diseases.



### COLD CATALYTIC FILTER

The cold catalytic filter removes chemicals such as carbon monoxide, hydrogen sulphide, ammonia, benzene and formaldehydes.

## COMFORT



### SMOOTH FAN SPEED ADJUSTMENT

This function allows smooth control of the indoor unit's fan capacity in a range of 1-100%.



### BREEZE AWAY FUNCTION

This function allows the blinds to be set in parallel so that the air supply from the unit is not directed directly at the user.



### AUTOMATIC RESTART

During a power outage, the air conditioner remembers the last settings and restores them when power is resumed. No need to reprogramme the device every time the power is switched off.



### EVAPORATOR SELF-CLEANING

After operation, the air conditioner goes into cleaning mode and removes any moisture that may have accumulated in the indoor unit. This prevents the growth of micro-organisms and fungi.



### 3D AIR SUPPLY

The horizontal and vertical blinds of the air conditioner are controlled automatically, in order to ensure uniform temperature distribution and optimal air circulation.



### 360° AIR SUPPLY

The unit can provide the best air distribution throughout the room thanks to the additional supply slots in the air conditioner panel.



### TURBO MODE

With this option, the air conditioner operates at an increased speed and provides rapid cooling or heating of the room.



### BROAD TEMPERATURE RANGE

Operating in a wide range of outdoor temperatures. In cooling mode from -15 to 50°C and from -25 to 30°C in heating mode.



### TEMPERATURE COMPENSATION

The unit compensates for differences in the temperature sensor reading on the indoor unit compared to the actual temperature at the room floor. The desired temperature is achieved throughout the room, not just around the air conditioner.



### COLD AIR SUPPLY CONTROL

To minimise the feeling of unpleasant cold air flow, the air conditioner automatically reduces the fan speed when it starts to operate in heating mode and increases it as the air warms up.



### MULTIFUNCTIONAL REMOTE CONTROL

Using the remote control, you can easily set the appropriate air parameters in the room. In addition, the remote control is equipped with practical functions such as: self-cleaning evaporator (SELF CLEAN), constant heating at 8°C (HEATING 8°C), temperature sensor (FOLLOW ME).



### COMPRESSOR AND CONDENSATE TRAY HEATER

The compressor crankcase heater prevents absorption of the refrigerant by the oil, which may occur when the temperature drops. The drip tray heater assists the air conditioner's operation in heating mode by preventing ice build-up, improving efficiency and minimising the risk of fan failure.



### VANE FUNCTION

With this option, the user can individually control each of the air conditioner's blinds, directing the airflow where they choose.



### QUIET OPERATION

Possibility to set the minimum sound level of the unit in the conditioned room.

## MONEY SAVING



### 8°C CONTINUOUS HEATING FUNCTION

When the user is away, in heating mode, the air conditioner keeps the room at a constant temperature of up to 8°C, preventing it from cooling down.



### STANDBY MODE

In standby mode, disconnecting power from unused components reduces power consumption by up to 80%.



### SLEEP FUNCTION

The unit raises the temperature set in cooling mode (lower in heating mode) by 1°C per hour within two hours and the fan operates at a low speed. This reduces electricity consumption and the air conditioning provides the best comfort for the user.



### 5 FAN SPEEDS FOR THE OUTDOOR UNIT

Thanks to inverter technology, the outdoor unit has 5 operating modes, which increases energy efficiency and improves comfort.



### TEMPERATURE SENSOR IN REMOTE CONTROL

The temperature sensor built into the remote control allows it to be measured closer to the user, allowing the device to more accurately match the environment.



### ECO

With the Eco function activated, the appliance consumes up to 60% less energy compared to conventional operation.



### GEAR FUNCTION

With the Gear Mode's ability to control the temperature and speed of air supply, it is possible to control electricity consumption and decide on the maximum intensity level.



### 12 FAN SPEEDS FOR THE INDOOR UNIT

Adjusting the 12 fan speeds of the indoor unit allows you to ensure maximum comfort in the room and save electricity.

## SAFETY



### CONDENSATE EVAPORATION

The condensed water is transported to the condenser where it evaporates. This eliminates the need for a condensate tank.



### OPERATION AT LOW OUTSIDE TEMPERATURES

The air conditioner operates in cooling mode even when the outside temperature reaches -15°C.



### OPERATION AT VERY LOW OUTSIDE TEMPERATURES

The air conditioner even works at outdoor temperatures as low as -25°C.



### ALARM PORT

The air conditioner has an alarm port from which a fault signal can be connected.



### REFRIGERANT LEAKAGE INDICATION

The error code will be displayed on the control panel of the indoor unit when the outdoor unit detects a refrigerant leakage.



### SELF-DIAGNOSIS

The air conditioner monitors its operation and shuts down if it detects a malfunction or failure. The error code is displayed on the control panel of the indoor unit.



### EMERGENCY USE

If one of the sensors fails, the operation of the unit is not interrupted and it can be used until the fault is rectified.



### ELECTRONIC EXPANSION VALVE

The electronic expansion valve reduces refrigerant pressure in a variable, controlled way. This makes it possible to accurately regulate both the superheat value and the cooling/heating capacity.

# Explore solutions you did not know

## KAISAI RANGE OF APPLIANCES

**KAISAI offers modern solutions ensuring comfort and efficient cooling of rooms inside the house - the living room, the bedroom or the children's room.**

The universal design of KAISAI air conditioners blends perfectly with the furnishings of any interior, and the high energy efficiency parameters ensure economical operation with low energy consumption.

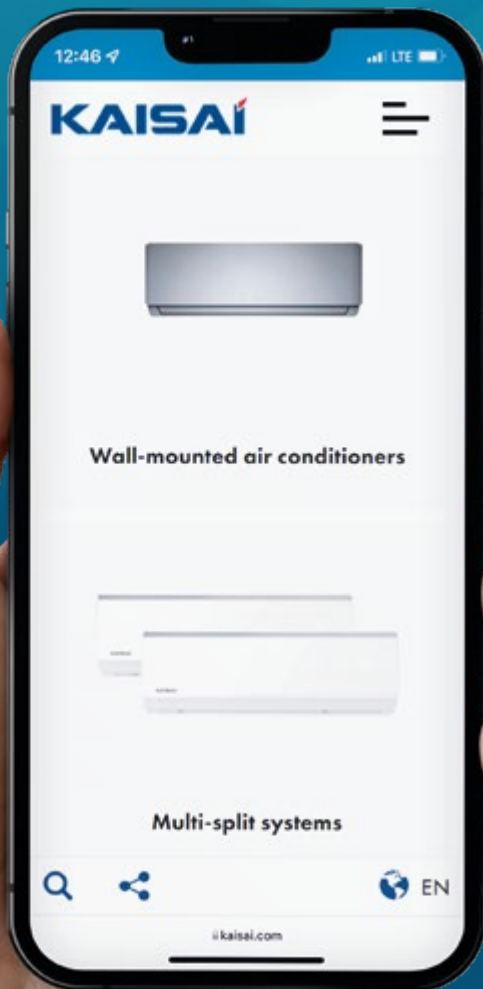

### **WALL-MOUNTED** AIR CONDITIONERS

Compact dimensions ensure a subtle, elegant appearance, and a range of unit types allows them to adapt to a variety of interiors – whether for home use, offices or retail outlets.

### **COMMERCIAL** AIR CONDITIONERS

Commercial buildings require equipment that provides a particularly efficient air conditioning system. Depending on the area and purpose of the facility, we can apply floor, floor/ceiling, cassette, duct, or condensing units.

### **MULTI SPLIT** SYSTEMS

These systems are recommended for facilities requiring multi-room air conditioning. All the advantages of split appliances are retained with a single outdoor unit.

### **PORTABLE** AIR CONDITIONERS

Portable air conditioners are used where it is not possible to install split air conditioning. They match the décor of home and office spaces thanks to their modern design.

# A planet-friendly home



Eco-friendly air conditioning, ventilation and heating systems reduce electricity consumption, giving real benefits during use. The offered Kaisai brand appliances are not only a high class of energy efficiency, but also innovative functionality that will meet the needs of the most demanding customers.

WALL FLOOR FLOOR AND CEILING CONSOLE CASSETTE COMPACT CASSETTE SUPER SLIM DUCT SLIM PORTABLE











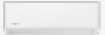

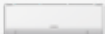



■ STANDARD  
□ OPTIONAL



|                                       | WALL | FLOOR | FLOOR AND CEILING | CONSOLE | CASSETTE COMPACT | CASSETTE SUPER SLIM | DUCT SLIM | PORTABLE |
|---------------------------------------|------|-------|-------------------|---------|------------------|---------------------|-----------|----------|
| Self-cleaning evaporator              | ■    |       | ■                 | ■       | ■                | ■                   |           |          |
| High-density filter                   | ■    |       |                   |         |                  |                     |           |          |
| The 3D air supply                     | ■    | ■     | ■                 | ■       |                  |                     |           |          |
| Automatic restart                     | ■    | ■     | ■                 | ■       | ■                | ■                   | ■         | ■        |
| 360° air supply                       |      |       |                   |         | ■                | ■                   |           |          |
| Temperature compensation              | ■    | ■     | ■                 | ■       | ■                | ■                   | ■         |          |
| Cold air control                      | ■    | ■     | ■                 | ■       | ■                | ■                   | ■         |          |
| Wide temperature range                | ■    | ■     | ■                 | ■       | ■                | ■                   | ■         |          |
| 8°C continuous heating function       | ■    | ■     | ■                 | ■       | ■                | ■                   |           |          |
| Standby mode                          | ■    |       |                   |         |                  |                     |           |          |
| Sleep function                        | ■    | ■     | ■                 | ■       | ■                | ■                   | ■         | ■        |
| Temperature sensor in remote control  | ■    | ■     | ■                 | ■       | ■                | ■                   | ■         |          |
| Condensate evaporation                |      |       |                   |         |                  |                     |           | ■        |
| Operation at low outside temperatures | ■    | ■     | ■                 | ■       | ■                | ■                   | ■         |          |
| Refrigerant leakage indication        | ■    | ■     | ■                 | ■       | ■                | ■                   | ■         |          |
| Emergency use                         | ■    | ■     | ■                 | ■       | ■                | ■                   | ■         |          |
| Self-diagnosis                        | ■    | ■     | ■                 | ■       | ■                | ■                   | ■         | ■        |
| Alarm port                            |      |       | ■                 |         | ■                | ■                   | ■         |          |
| Timer                                 | ■    | ■     | ■                 | ■       | ■                | ■                   | ■         | ■        |
| Automatic blinds (swing)              | ■    | ■     | ■                 | ■       | ■                | ■                   |           | ■        |
| Mono and multi                        | ■    |       |                   | ■       | ■                |                     | ■         |          |
| Simple installation                   |      |       |                   |         |                  |                     |           | ■        |
| Twin combination                      |      |       | ■                 |         |                  | ■                   | ■         |          |
| Double-sided installation             | ■    |       | ■                 | ■       |                  |                     | ■         |          |
| Fresh air                             |      |       | ■                 |         | ■                | ■                   | ■         |          |
| Blinds settings memory                | ■    |       | ■                 | ■       | ■                | ■                   |           |          |
| On-off port                           |      |       | ■                 |         | ■                | ■                   | ■         |          |
| Multidirectional castors              |      |       |                   |         |                  |                     |           | ■        |
| Wi-Fi control                         | ■    |       | □                 | □       | □                | ■                   | □         |          |
| Built-in condensate pump              |      |       | ■                 |         | ■                | ■                   | ■         |          |

# Series of

## KAISAI AIR CONDITIONING APPLIANCES

| TYPE  | COOLING / HEATING CAPACITY [kW] |     |     |     |     |         |  |
|---|---------------------------------|-----|-----|-----|-----|---------|--|
|   | PAGE NUMBER                     | 2,6 | 3,5 | 5,3 | 6,0 | 7,0+7,2 |  |
| <b>WALL-MOUNTED AIR CONDITIONERS</b>  |                                 |     |     |     |     |         |  |
|  FLY                   | 52                              | •   | •   | •   |     | •       |  |
|  ICE                   | 56                              | •   | •   | •   |     | •       |  |
|  GEO                   | 60                              | •   | •   | •   |     | •       |  |
|  PRO HEAT              | 64                              | •   | •   | •   |     | •       |  |
| <b>MULTI SPLIT SYSTEMS</b>  |                                 |     |     |     |     |         |  |
|  WALL                  | 70                              | •   | •   | •   |     | •       |  |
|  DUCT                | 71                              |     |     | •   |     |         |  |
|  CONSOLE             | 72                              |     | •   | •   |     |         |  |
|  CASSETTE COMPACT    | 71                              | •   | •   | •   |     |         |  |
|  OUTDOOR UNITS       | 72                              |     |     | •   |     |         |  |
| <b>COMMERCIAL AIR CONDITIONERS</b>  |                                 |     |     |     |     |         |  |
|  FLOOR               | 76                              |     |     |     |     | •       |  |
|  FLOOR AND CEILING   | 84                              |     |     | •   |     | •       |  |
|  CONSOLE             | 88                              |     | •   | •   |     |         |  |
|  CASSETTE COMPACT    | 92                              |     | •   | •   |     |         |  |
|  CASSETTE SUPER SLIM | 96                              |     |     |     |     | •       |  |
|  DUCT SLIM           | 100                             |     |     | •   |     | •       |  |
|  CONDENSING UNITS    | 104                             |     | •   | •   |     | •       |  |
| <b>PORTABLE AIR CONDITIONERS</b>  |                                 |     |     |     |     |         |  |
|  KPPH                | 108                             | •   |     |     |     |         |  |



COOLING / HEATING CAPACITY [kW]

7,9÷8,2

9,0

10,0

10,6

12,0÷12,4

14,0÷14,1

15,2÷15,8

|  |  |  |  |  |  |  |  |
|--|--|--|--|--|--|--|--|
|  |  |  |  |  |  |  |  |
|  |  |  |  |  |  |  |  |
|  |  |  |  |  |  |  |  |
|  |  |  |  |  |  |  |  |

|  |    |  |  |   |   |  |  |
|--|----|--|--|---|---|--|--|
|  |    |  |  |   |   |  |  |
|  |    |  |  |   |   |  |  |
|  |    |  |  |   |   |  |  |
|  |    |  |  |   |   |  |  |
|  | •• |  |  | • | • |  |  |

|  |  |  |  |   |  |   |   |
|--|--|--|--|---|--|---|---|
|  |  |  |  |   |  | • |   |
|  |  |  |  | • |  | • | • |
|  |  |  |  |   |  |   |   |
|  |  |  |  | • |  | • | • |
|  |  |  |  | • |  | • | • |
|  |  |  |  | • |  | • | • |

|  |  |  |  |  |  |  |  |
|--|--|--|--|--|--|--|--|
|  |  |  |  |  |  |  |  |
|--|--|--|--|--|--|--|--|

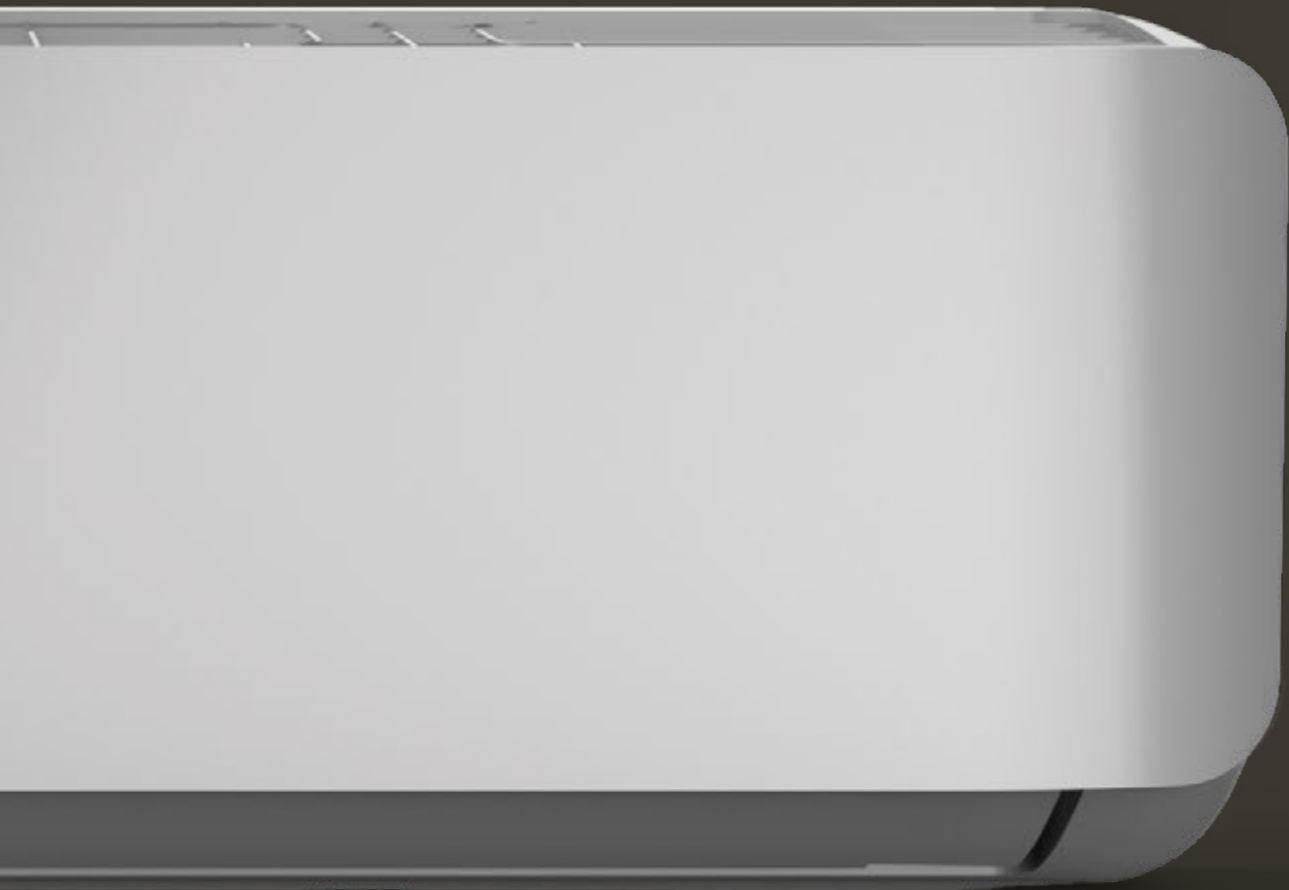

# Wall-mounted air conditioners

**The compact dimensions of the wall-mounted units provide an elegant appearance and comfort of use, combined with high efficiency and simple installation.**

All wall-mounted KAISAI air conditioners use the environmentally friendly R32 refrigerant, and standard accessories include the Wi-Fi function to control the unit using mobile devices. Depending on the model, there is a number of practical functions available for intuitive control and the optimum adaptation of the device to the needs of the user.



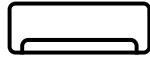

KWX 09 | 12 | 18 | 24 KRHI

# fly

**The energy-efficient Kaisai Fly wall air conditioner with R32 refrigerant combines elegance with functionality. Its universal, timeless design makes it fit into any interior.**

The unit stands out for its ability to heat at outdoor temperatures as low as -25°C. The Wi-Fi function as standard increases the convenience of air conditioning control, and a modern wireless remote control allows you to use 3 additional functions: self-cleaning evaporator (Self Clean), constant heating at 8°C (Heating 8°C) and temperature sensor in the remote control (Follow Me).





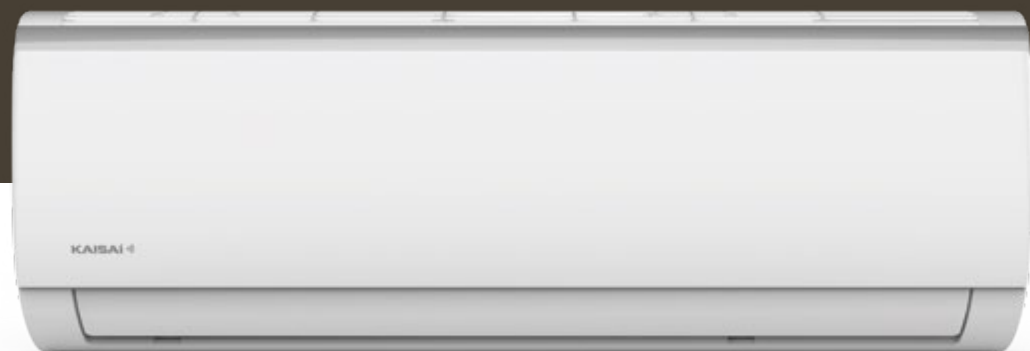





















A<sup>+</sup>

R32





## Features of **Kaisai Fly**

|   |   |   |   |   |   |   |   |  |   |   |   |   |
|---|---|---|---|---|---|---|---|--|---|---|---|---|
|  |  |  |  |  |  |  |  |  |  |  |  |  |
| Wide temperature range  | High-density filter   | Blinds settings memory  | Refrigerant leakage indication  | Operation at low outside temperatures   | Multi-functional remote control   | Emergency use   | Cold-catalytic filter   | Wi-Fi control  | Standby mode  | Heating function 8°C  | Turbo mode  | Self-cleaning evaporator  |
|  |  |  |  |  |  |  |  |  |  |  |  |  |
| 3D air supply   | Sleep function  | Mono and multi  | Timer   | Automatic restart   | Self-diagnosis  | Remote control temperature sensor   | BIO HEPA filter   | Compressor and condensate tray heaters   | Eco   | OPTIONAL<br>Silver ion filter   | OPTIONAL<br>Vitamin C filter  | OPTIONAL<br>3M filter   |

## Technical specification

| MODEL                                 | indoor unit     |                  | KWX-09KRHI    | KWX-12KRHI        | KWX-18KRHI     | KWX-24KRHI     |
|---------------------------------------|-----------------|------------------|---------------|-------------------|----------------|----------------|
|                                       | outdoor unit    |                  | KWX-09KRHO    | KWX-12KRHO        | KWX-18KRHO     | KWX-24KRHO     |
| Capacity average (min÷max)            | cooling         | kW               | 2,6(0,9÷3,4)  | 3,5(1,1÷3,9)      | 5,3(1,8÷6,1)   | 7,0(2,1÷7,9)   |
|                                       | heating         | kW               | 2,9(0,8÷3,4)  | 3,8(1,1÷4,2)      | 5,6(1,3÷6,7)   | 7,3(1,6÷7,9)   |
| Energy class                          | cooling/heating |                  | A++/A+        | A++/A+            | A++/A+         | A++/A+         |
| SEER                                  | average         | W/W              | 7,0           | 6,5               | 7,4            | 6,1            |
| SCOP                                  | average         | W/W              | 4,1           | 4,1               | 4,0            | 4,0            |
| Average power consumption (min÷max)   | cooling         | W                | 800(100÷1240) | 1320(83÷1600)     | 1550(140÷2300) | 2600(420÷3150) |
|                                       | heating         | W                | 930(120÷1200) | 1190(167÷1400)    | 1570(220÷2350) | 2400(300÷2750) |
| Average operating current (min÷max)   | cooling         | A                | 3,48(0,4÷5,4) | 5,8(0,8÷7,3)      | 6,7(0,6÷10,0)  | 11,5(1,8÷13,8) |
|                                       | heating         | A                | 4,05(0,5÷5,5) | 5,3(1,4÷6,4)      | 6,8(0,9÷10,2)  | 11,0(1,3÷12,2) |
| Air flow rate                         | indoor          | m³/h             | 435/333/259   | 530/430/310       | 840/680/540    | 980/817/662    |
|                                       | outdoor         | m³/h             | 1750          | 1750              | 2100           | 3500           |
| Operating temperature cooling/heating | indoor          | °C               | 17÷32/0÷30    | 17÷32/0÷30        | 17÷32/0÷30     | 17÷32/0÷30     |
|                                       | outdoor         | °C               | -15÷50/-25÷30 | -15÷50/-25÷30     | -15÷50/-25÷30  | -15÷50/-25÷30  |
| Sound pressure level                  | indoor          | dB(A)            | 37/32/25/21,5 | 39,5/35,5/25/21,5 | 42,5/36/26/20  | 45/40,5/36/30  |
|                                       | outdoor         | dB(A)            | 55            | 55                | 56             | 59             |
| Net dimensions w/h/d                  | indoor          | mm               | 715/285/194   | 805/285/194       | 957/302/213    | 1040/327/220   |
|                                       | outdoor         | mm               | 720/495/270   | 720/495/270       | 805/554/330    | 890/673/342    |
| Transport dimensions w/h/d            | indoor          | mm               | 780/365/270   | 870/365/270       | 1035/385/295   | 1120/405/315   |
|                                       | outdoor         | mm               | 835/540/300   | 835/540/300       | 915/615/370    | 995/740/398    |
| Net weight                            | indoor          | kg               | 6,7           | 7,3               | 10,0           | 12,3           |
|                                       | outdoor         | kg               | 21            | 21                | 32,7           | 42,9           |
| Transport weight                      | indoor          | kg               | 8,8           | 9,5               | 13,0           | 15,8           |
|                                       | outdoor         | kg               | 22,8          | 22,8              | 35,4           | 45,9           |
| Pipe diameter: liquid/gas             |                 | mm               | 6,35/9,52     | 6,35/9,52         | 6,35/12,7      | 9,52/15,9      |
| Maximum installation length           |                 | m                | 25            | 25                | 30             | 50             |
| Maximum height difference             |                 | m                | 10            | 10                | 20             | 25             |
| Power supply                          | outdoor         | V/Hz/Ph          | 220÷240/50/1  | 220÷240/50/1      | 220÷240/50/1   | 220÷240/50/1   |
| Circuit breaker/fuse                  | outdoor         | A                | 10            | 16                | 16             | 20             |
| Power supply lines                    | outdoor         | # of wires x mm² | 3x1,5         | 3x1,5             | 3x2,5          | 3x2,5          |
| Control lines                         | ind. - outd.    | # of wires x mm² | 5x1,5         | 5x1,5             | 5x1,5          | 5x1,5          |
| Factory amount of refrigerant         | up to 5 rm      | kg               | 0,47          | 0,52              | 1,08           | 1,42           |
| Additional amount of refrigerant      | over 5 rm       | g/m              | 12            | 12                | 12             | 24             |

## Controllers

WIRELESS  
REMOTE CONTROL



**RG10A4**

WIRELESS  
REMOTE CONTROL



**RG10B  
(OPCJA)**

WIRED REMOTE  
CONTROL



**KJR12B  
(OPCJA)**





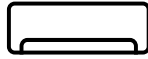

KLB-09 | 12 | 18 | 24 HRHI  
KLB-09 | 12 | 18 | 24HRHI

# ice

**Wall air conditioner with stylish panel in two color variants: crystal white and mirror black.**

A high energy class and a number of features that take care of the health and high comfort of the user comfort are additional hallmarks of this model. Kaisai Ice is equipped with compressor and condensate tray heaters, an ionizer air and a Bio HEPA filter. In addition to the standard control capabilities control, it offers rich additional options, such as connecting a controller central controller or a BMS gateway.

A<sup>++</sup> | R32 | 

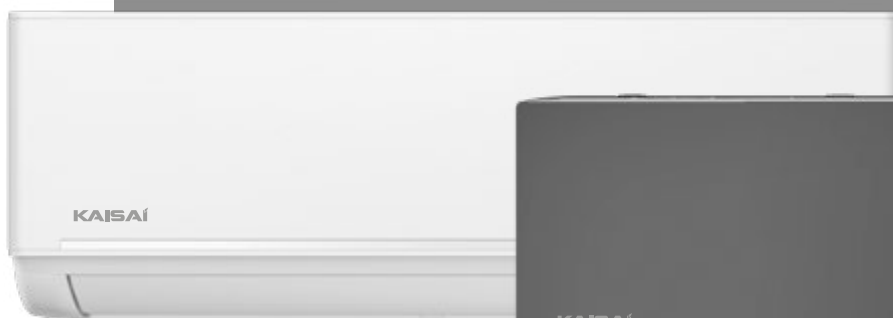

KLB

KLB



KLB

88 



## Features of **Kaisai Ice**



Wide temperature range



Simple installation



Blinds settings memory



Refrigerant leakage indication



Operation at low outside temperatures



BIO HEPA filter



Emergency use



Wi-Fi control



Standby mode



Multi-functional remote control



Heating function 8°C



Self-cleaning evaporator



3D air supply



Sleep function



Timer



Automatic restart



Self-diagnosis



Remote control temperature sensor



Air ionization



Compressor and condensate tray heaters



Gear mode



Eco mode



Smooth fan speed adjustment



Mono & multi



Turbo mode



Silver ion filter



Vitamin C filter



3M filter



MFB module

## Technical specification

| MODEL                               | indoor unit     |            | KLW-09HRHI    | KLW-12HRHI      | KLW-18HRHI      | KLW-24HRHI      |      |
|-------------------------------------|-----------------|------------|---------------|-----------------|-----------------|-----------------|------|
|                                     | outdoor unit    |            | KLB-09HRHI    | KLB-12HRHI      | KLB-18HRHI      | KLB-24HRHI      |      |
|                                     |                 |            | KLWB-09HRHO   | KLWB-12HRHO     | KLWB-18HRHO     | KLWB-24HRHO     |      |
| Capacity average (min÷max)          | cooling         | kW         | 2,6 (1,0-3,2) | 3,5 (1,4-4,3)   | 5,3 (1,9-6,2)   | 7,0 (3,0-8,7)   |      |
|                                     | heating         | kW         | 2,9 (0,8-3,4) | 3,8 (1,1-4,4)   | 5,6 (1,3-6,9)   | 7,3 (1,5-9,3)   |      |
| Energy class                        | cooling/heating |            | A+++ / A++    | A+++ / A++      | A++ / A+        | A++ / A+        |      |
| SEER                                | average         | W/W        | 8,8           | 8,5             | 7,0             | 6,4             |      |
| SCOP                                | average         | W/W        | 4,6           | 4,6             | 4,0             | 4,0             |      |
| Average power consumption (min÷max) | cooling         | W          | 628 (80÷1100) | 1005 (130÷1650) | 1550 (150÷2250) | 2420 (340÷3450) |      |
|                                     | heating         | W          | 651 (70÷990)  | 977 (160÷1560)  | 1630 (220÷2350) | 2130 (300÷3150) |      |
| Average operating current (min÷max) | cooling         | A          | 2,7 (0,3÷4,8) | 4,4 (0,6÷7,2)   | 6,7 (0,7÷9,8)   | 10,5 (1,4÷15)   |      |
|                                     | heating         | A          | 2,8 (0,3÷4,3) | 4,2 (0,7÷6,8)   | 7,1 (0,9÷10,2)  | 9,3 (1,3÷13,7)  |      |
| Air flow rate                       | indoor          | m³/h       | 510/360/300   | 520/370/310     | 800/600/500     | 1090/770/610    |      |
|                                     | outdoor         | m³/h       | 2150          | 2200            | 2100            | 3500            |      |
| Operating temp. cooling/heating     | indoor          | °C         | 17÷32/0÷30    | 17÷32/0÷30      | 17÷32/0÷30      | 17÷32/0÷30      |      |
|                                     | outdoor         | °C         | -15+50/-25+30 | -15+50/-25+30   | -15+50/-25+30   | -15+50/-25+30   |      |
| Sound pressure level                | indoor          | dB(A)      | 37/31/22/19   | 39/33/22/21     | 41/37/31/20     | 46/37/34,5/21   |      |
|                                     | outdoor         | dB(A)      | 54,0          | 54,5            | 57,0            | 60,0            |      |
| Net dimensions w/h/d                | indoor          | mm         | 835x295x208   | 835x295x208     | 969x320x241     | 1083x336x244    |      |
|                                     | outdoor         | mm         | 765x555x303   | 765x555x303     | 805x554x330     | 890x673x342     |      |
| Transport dimensions w/h/d          | indoor          | mm         | 905x355x290   | 905x355x290     | 1045x405x315    | 1155x415x315    |      |
|                                     | outdoor         | mm         | 887x610x337   | 887x610x337     | 915x615x370     | 995x740x398     |      |
| Net weight                          | indoor          | kg         | 8,7           | 8,7             | 11,2            | 13,6            |      |
|                                     | outdoor         | kg         | 26,4          | 26,4            | 33,5            | 43,9            |      |
| Transport weight                    | indoor          | kg         | 11,5          | 11,5            | 14,6            | 17,3            |      |
|                                     | outdoor         | kg         | 28,8          | 28,8            | 36,1            | 46,9            |      |
| Pipe diameter: liquid/gas           |                 | mm         | 6,35/9,52     | 6,35/9,52       | 6,35/12,7       | 9,52/15,9       |      |
| Maximum installation length         |                 | m          | 25            | 25              | 30              | 50              |      |
| Maximum height difference           |                 | m          | 10            | 10              | 20              | 25              |      |
| Power supply                        | outdoor         | V/Hz/Ph    | 220-240/50/1  | 220-240/50/1    | 220-240/50/1    | 220-240/50/1    |      |
| Circuit breaker/fuse                | outdoor         | A          | 10            | 16              | 16              | 20              |      |
| Power supply lines                  | outdoor         | # of wires | 3x1,5         | 3x1,5           | 3x2,5           | 3x2,5           |      |
| Control lines                       | ind. - outd.    | x mm²      | 5x1,5         | 5x1,5           | 5x1,5           | 5x1,5           |      |
| Refrigerant                         | factory amt.    | up to 5 rm | kg            | 0,62            | 0,62            | 1,1             | 1,45 |
|                                     | add amt.        | over 5 rm  | g/m           | 12              | 12              | 12              | 24   |

KLW – white indoor unit / KLB – black indoor unit

## Controllers

WIRELESS  
REMOTE CONTROL



**RG10A1**

WIRED REMOTE  
CONTROL



**KJR12B  
(OPTIONAL)**

WIRED REMOTE  
CONTROL



**KJR-120X2  
(OPTIONAL)**

WIRED REMOTE  
CONTROL



**KJR-120N  
(OPTIONAL)**

WIRED REMOTE  
CONTROL



**CCM  
(OPTIONAL)**



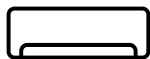

KGE-09 | 12 | 18 | 24 GRHI

# geo

**Geo units offer the highest energy efficiency class and modern air purification functions.**

The Geo air conditioner series is the perfect combination of original design and top energy class A+++ in cooling mode and A+++ in heating mode. Thanks to the double filtration system and the air ionisation function, the device effectively cleans the air-conditioned room from dust, microbes and unwanted chemical substances. High comfort of use of the air conditioner is ensured by the Wi-Fi module as standard and the 3D air intake allowing for optimal air circulation and even temperature distribution in the room.





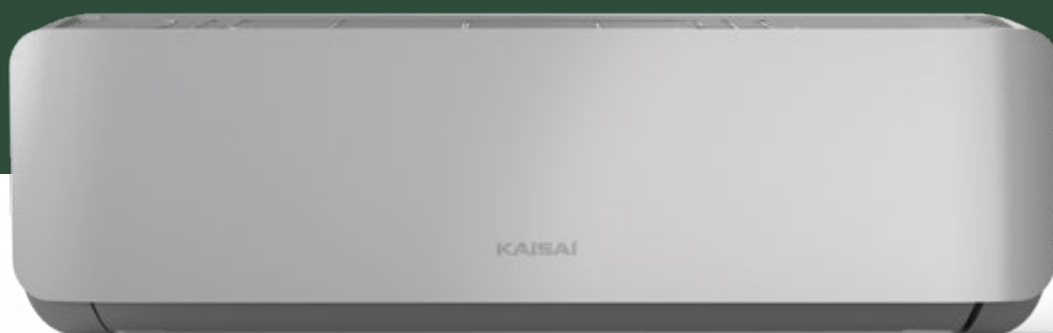



















A<sup>+++</sup>

R32





## Features of **Kaisai Geo**

- |   |   |   |   |   |   |   |   |  |   |   |   |   |
|---|---|---|---|---|---|---|---|--|---|---|---|---|
|  |  |  |  |  |  |  |  |  |  |  |  |  |
| Wide temperature range  | Simple installation   | Blinds settings memory  | Refrigerant leakage indication  | Operation at low outside temperatures   | Timer   | Emergency use   | Multi-functional remote control   | Standby mode   | Wi-Fi control   | Heating function 8°C  | Turbo mode  | Self-cleaning evaporator  |
|  |  |  |  |  |  |  |  |  |  |  |  |   |
| 3D air supply   | Sleep function  | Automatic restart   | Self-diagnosis  | Remote control temperature sensor   | Cold-catalytic filter   | BIO HEPA filter   | Air ionization  | Compressor and condensate tray heaters   | OPTIONAL<br>Silver ion filter   | OPTIONAL<br>Vitamin C filter  | OPTIONAL<br>3M filter   |   |

## Technical specification

| MODEL                                 | indoor unit     |                   | KGE-09GRHI     | KGE-12GRHI    | KGE-18GRHI     | KGE-24GRHI     |
|---------------------------------------|-----------------|-------------------|----------------|---------------|----------------|----------------|
|                                       | outdoor unit    |                   | KGE-09GRHO     | KGE-12GRHO    | KGE-18GRHO     | KGE-24GRHO     |
| Capacity average (min÷max)            | cooling         | kW                | 2,6(1,0÷3,2)   | 3,5(1,4÷4,3)  | 5,3(3,4÷5,9)   | 7,0(2,1÷8,2)   |
|                                       | heating         | kW                | 2,9(0,8÷3,4)   | 3,8(1,1÷4,4)  | 5,6(3,1÷5,8)   | 7,3(1,5÷8,5)   |
| Energy class                          | cooling/heating |                   | A+++/A++       | A+++/A++      | A++/A+         | A++/A+         |
| SEER                                  | average         | W/W               | 9,3            | 8,5           | 7,0            | 6,5            |
| SCOP                                  | average         | W/W               | 4,6            | 4,6           | 4,0            | 4,0            |
| Average power consumption (min÷max)   | cooling         | W                 | 613(90÷1140)   | 977(130÷1650) | 1550(560÷2050) | 2510(420÷3200) |
|                                       | heating         | W                 | 637(110÷1080)  | 977(160÷1560) | 1500(780÷2000) | 2130(300÷3100) |
| Average operating current (min÷max)   | cooling         | A                 | 2,66(0,4÷4,7)  | 4,2(0,6÷7,2)  | 6,7(2,4÷9,0)   | 10,9(1,8÷13,9) |
|                                       | heating         | A                 | 2,77(0,48÷4,7) | 4,2(0,7÷6,8)  | 6,5(3,4÷8,7)   | 9,3(1,3÷13,5)  |
| Air flow rate                         | indoor          | m <sup>3</sup> /h | 483/362/303    | 584/477/395   | 730/500/420    | 1020/830/640   |
|                                       | outdoor         | m <sup>3</sup> /h | 2150           | 2100          | 2200           | 3500           |
| Operating temperature cooling/heating | indoor          | °C                | 17÷32/0÷30     | 17÷32/0÷30    | 17÷32/0÷30     | 17÷32/0÷30     |
|                                       | outdoor         | °C                | -15÷50/-25÷24  | -15÷50/-25÷24 | -15÷50/-25÷24  | -15÷50/-25÷24  |
| Sound pressure level                  | indoor          | dB(A)             | 36,5/29,0/24,0 | 39,5/33/25    | 43/33,5/28     | 47/41,5/30,5   |
|                                       | outdoor         | dB(A)             | 54             | 54,5          | 55,5           | 60,5           |
| Net dimensions w/h/d                  | indoor          | mm                | 802/297/189    | 802/297/189   | 965/319/215    | 1080/335/226   |
|                                       | outdoor         | mm                | 765/555/303    | 765/555/303   | 805/554/330    | 890/673/342    |
| Transport dimensions w/h/d            | indoor          | mm                | 875/380/285    | 875/380/285   | 1045/410/305   | 1155/415/320   |
|                                       | outdoor         | mm                | 887/610/337    | 887/610/337   | 915/615/370    | 995/740/398    |
| Net weight                            | indoor          | kg                | 8,6            | 8,6           | 10,9           | 13,7           |
|                                       | outdoor         | kg                | 26,7           | 26,7          | 33,5           | 43,9           |
| Transport weight                      | indoor          | kg                | 11,1           | 11,1          | 14,2           | 17,3           |
|                                       | outdoor         | kg                | 29,1           | 29,1          | 36,1           | 46,9           |
| Pipe diameter: liquid/gas             |                 | mm                | 6,35/9,52      | 6,35/9,52     | 6,35/12,7      | 9,52/15,9      |
| Maximum installation length           |                 | m                 | 25             | 25            | 30             | 30             |
| Maximum height difference             |                 | m                 | 10             | 10            | 20             | 20             |
| Power supply                          | outdoor         | V/Hz/Ph           | 220÷240/50/1   | 220÷240/50/1  | 220÷240/50/1   | 220÷240/50/1   |
| Circuit breaker/fuse                  | outdoor         | A                 | 10             | 10            | 16             | 20             |
| Power supply lines                    | outdoor         | # of wires        | 3x1,5          | 3x1,5         | 3x1,5          | 3x2,5          |
| Control lines                         | ind. - outd.    | x mm <sup>2</sup> | 5x1,5          | 5x1,5         | 5x1,5          | 5x1,5          |
| Factory amount of refrigerant         | up to 5 rm      | kg                | 0,62           | 0,62          | 1,1            | 1,45           |
| Additional amount of refrigerant      | over 5 rm       | g/m               | 12             | 12            | 12             | 24             |

## Controllers

WIRELESS  
REMOTE CONTROL

**RG10B1**







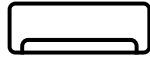

KRP 09 | 12 | 18 | 24 MEGI

# pro heat

**A wall-mounted air conditioner designed for energy-efficient and reliable heating, characterized by exceptionally high energy efficiency coefficients and the ability to efficiently heat rooms at outdoor temperatures down to -25°C.**





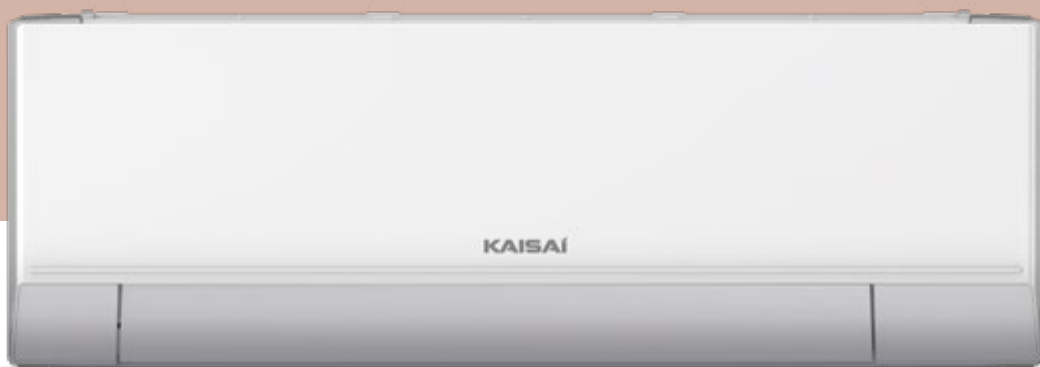























ProHeat combines modern design with high comfort thanks to the air ionization function and advanced air purification filters.

A<sup>++</sup> | R32 | 





## Features of **Kaisai Pro Heat**

|   |   |   |   |   |   |   |   |  |   |   |   |   |
|---|---|---|---|---|---|---|---|--|---|---|---|---|
|  |  |  |  |  |  |  |  |  |  |  |  |  |
| Wide temperature range  | High-density filter   | Blinds settings memory  | Refrigerant leakage indication  | Operation at low outside temperatures   | Timer   | Emergency use   | Double sided installation   | Standby mode   | Heating function 8°C  | Air ionization  | Smooth fan speed adjustment   | Self-diagnosis  |
|  |  |  |  |  |  |  |  |  |  |  |  |   |
| 3D air supply   | Sleep function  | Eco   | Wi-Fi control   | Automatic restart   | Gear mode   | Remote control temperature sensor   | Turbo mode  | Cold-catalytic filter  | BIO HEPA filter   | Electronic expansion valve  | Compressor and condensate tray heaters  |   |
| <b>OPTIONAL</b>   | <b>OPTIONAL</b>   | <b>OPTIONAL</b>   | <b>OPTIONAL</b>   |   |   |   |   |  |   |   |   |   |
|  |  |  |  |   |   |   |   |  |   |   |   |   |
| Silver ion filter   | Vitamin C filter  | 3M filter   | MFB module  |   |   |   |   |  |   |   |   |   |

## Technical specification

| MODEL                               | indoor unit     |                  | KRP-09MEGI      | KRP-12MEGI    | KRP-18MEGI      | KRP-24MEGI     |
|-------------------------------------|-----------------|------------------|-----------------|---------------|-----------------|----------------|
|                                     | outdoor unit    |                  | KRP-09MEGO      | KRP-12MEGO    | KRP-18MEGO      | KRP-24MEGO     |
| Capacity average (min÷max)          | cooling         | kW               | 2,7(1,3-3,8)    | 3,5(1,3-3,9)  | 5,3(3,7-6,1)    | 7,0(2,1-8,2)   |
|                                     | heating         | kW               | 3,1(0,9-4,4)    | 3,9(0,9-4,5)  | 5,6(2,6-6,7)    | 7,3(1,6-8,2)   |
| Energy class                        | cooling/heating |                  | A+++ / A++      | A+++ / A++    | A+++/A+         | A+++/A+        |
| SEER                                | average         | W/W              | 8,6             | 8,5           | 8,5             | 8,5            |
| SCOP                                | average         | W/W              | 4,6             | 4,6           | 4,3             | 4,2            |
| Average power consumption (min÷max) | cooling         | W                | 600(130÷1200)   | 880(130÷1250) | 1318(587÷1787)  | 1760(420÷3200) |
|                                     | heating         | W                | 690(120÷1400)   | 990(120÷1450) | 1500(943÷1695)  | 1975(300÷3100) |
| Average operating current (min÷max) | cooling         | A                | 2,66(0.6÷5.35)  | 3,9(0.6÷5.55) | 5,73(2.81÷7.90) | 7,7(1.8÷13.9)  |
|                                     | heating         | A                | 3,05(0.6÷6.2)   | 4,4(0.6÷6.4)  | 6,52(4.26÷7.50) | 8,6(1.3÷13.5)  |
| Air flow rate                       | indoor          | m³/h             | 530/360/280     | 560/380/290   | 685/580/400     | 1092/724/379   |
|                                     | outdoor         | m³/h             | 2200            | 2200          | 3500            | 3500           |
| Operating temp. cooling/heating     | indoor          | °C               | 16÷32/0÷30      | 16÷32/0÷30    | 16÷32/0÷30      | 16÷32/0÷30     |
|                                     | outdoor         | °C               | -15÷50/-25÷24   | -15÷50/-25÷24 | -15÷50/-25÷24   | -15÷50/-25÷24  |
| Sound pressure level                | indoor          | dB(A)            | 37/32/21,5/20,5 | 40/33/22/21   | 41/35/23/22     | 44,5/40/33/21  |
|                                     | outdoor         | dB(A)            | 57              | 57,5          | 56              | 58,5           |
| Net dimensions w/h/d                | indoor          | mm               | 795x295x225     | 795x295x225   | 965x319x239     | 1140x370x275   |
|                                     | outdoor         | mm               | 805x554x330     | 805x554x330   | 890x673x342     | 890x673x342    |
| Transport dimensions w/h/d          | indoor          | mm               | 870x370x305     | 870x370x305   | 1045x400x325    | 1230x455x355   |
|                                     | outdoor         | mm               | 915x615x370     | 915x615x370   | 995x740x398     | 995x740x398    |
| Net weight                          | indoor          | kg               | 10,2            | 10,2          | 12,3            | 20,0           |
|                                     | outdoor         | kg               | 28,4            | 28,4          | 38,8            | 45,6           |
| Transport weight                    | indoor          | kg               | 13              | 13            | 16,4            | 25,3           |
|                                     | outdoor         | kg               | 31,0            | 31,0          | 41,9            | 48,8           |
| Pipe diameter: liquid/gas           |                 | mm               | 6,35/9,52       | 6,35/9,52     | 6,35/12,70      | 9,52/15,90     |
| Maximum installation length         |                 | m                | 25              | 25            | 30              | 50             |
| Maximum height difference           |                 | m                | 10              | 10            | 20              | 25             |
| Power supply                        | outdoor         | V/Hz/Ph          | 220-240/50/1    | 220-240/50/1  | 220-240/50/1    | 220-240/50/1   |
| Circuit breaker/fuse                | outdoor         | A                | 10              | 16            | 16              | 20             |
| Power supply lines                  | outdoor         | # of wires x mm² | 3x1,5           | 3x1,5         | 3x2,5           | 3x2,5          |
| Control lines                       | ind. - outd.    | # of wires x mm² | 5x1,5           | 5x1,5         | 5x1,5           | 5x1,5          |
| Factory amount of refrigerant       | up to 5 rm      | kg               | 0,69            | 0,69          | 1,10            | 1,50           |
| Additional amount of refrigerant    | over 5 rm       | g/m              | 12              | 12            | 12              | 24             |

## Controllers

WIRELESS  
REMOTE CONTROL



**RG10A1**

WIRED REMOTE  
CONTROL



**KJR12B  
(OPTIONAL)**

WIRED REMOTE  
CONTROL



**KJR-120X2  
(OPTIONAL)**

WIRED REMOTE  
CONTROL



**KJR-120N  
(OPTIONAL)**

WIRED REMOTE  
CONTROL



**CCM  
(OPTIONAL)**

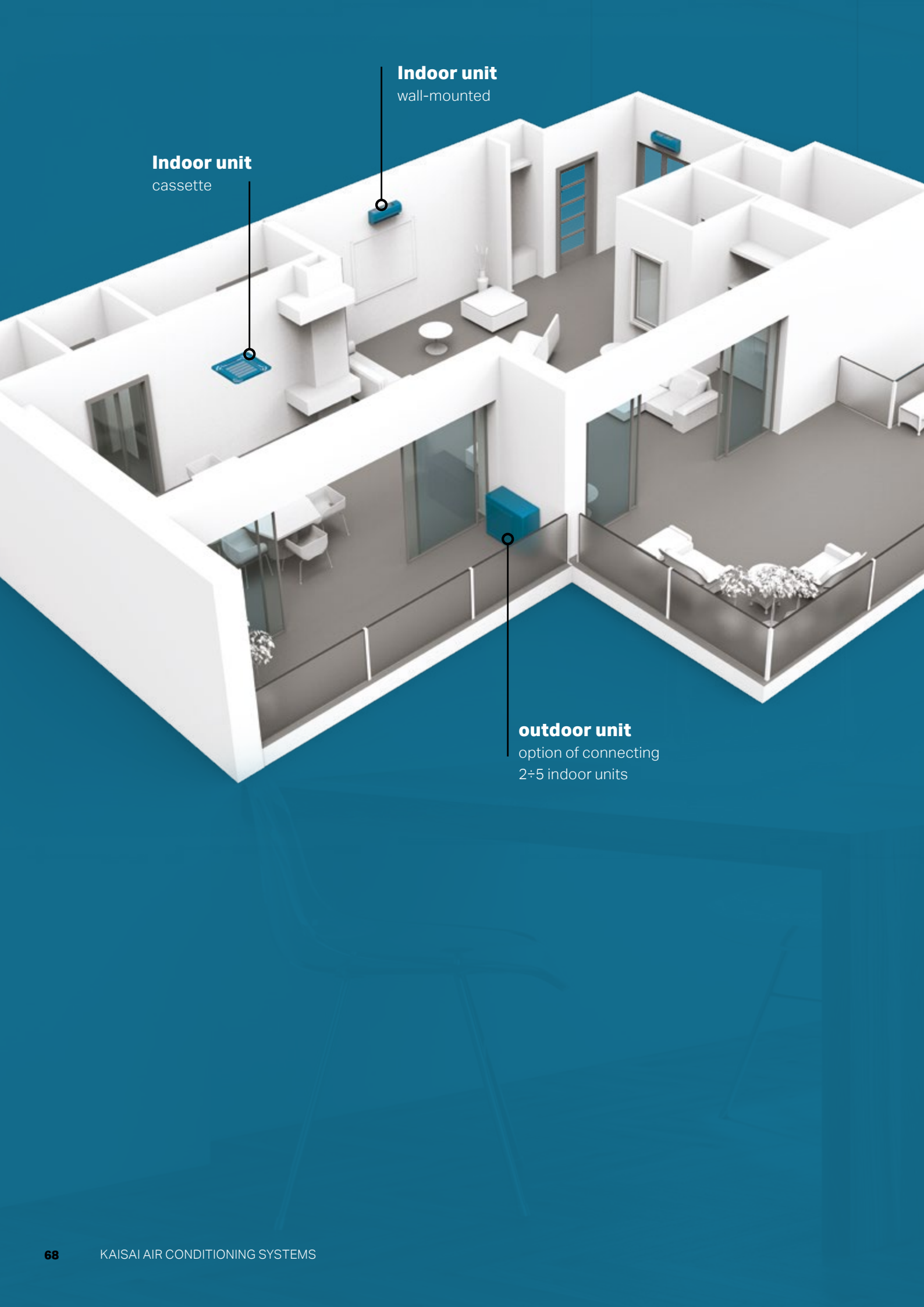

**Indoor unit**  
cassette

**Indoor unit**  
wall-mounted

**outdoor unit**  
option of connecting  
2÷5 indoor units



# Multi split systems

**Multi Split air conditioners are extremely energy-efficient units. The system allows the connection from 2 to 5 Fly, One+ or Ice wall units, kompakt cassette, console or duct units to one (external) unit.**

Each of the indoor units operates individually, has the option of independently adjusting the temperature and adjusting the power to the users' needs. When buying a Multi Split air conditioner, it is important to select the cooling capacity needed for each room in which the wall or cassette air conditioner will be placed.

The selected units are installed in the rooms and at the very end, each of the air conditioners is connected to a pre-installed single large unit (outdoor unit). This way, there is no need to install an indoor and an outdoor unit for each room.

# Indoor units

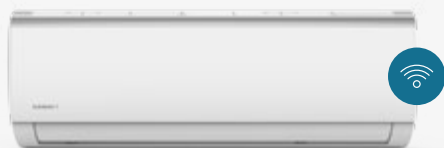

## KWX 09 | 12 | 18 | 24 KRHI

WI-FI AS A STANDARD

| MODEL                |                   |         | KWX-09KRHI    | KWX-12KRHI        | KWX-18KRHI    | KWX-24KRHI    |
|----------------------|-------------------|---------|---------------|-------------------|---------------|---------------|
| Power supply         |                   | V/Hz/Ph | 220÷240/50/1  | 220÷240/50/1      | 220÷240/50/1  | 220÷240/50/1  |
| Capacity             | cooling           | kW      | 2,6           | 3,5               | 5,3           | 7,0           |
|                      | heating           | kW      | 2,9           | 3,8               | 5,6           | 7,3           |
| Air flow rate        |                   | m³/h    | 435/333/259   | 530/430/310       | 840/680/540   | 980/817/662   |
| Sound pressure level | (high/medium/low) | dB(A)   | 37/32/25/21,5 | 39,5/35,5/25/21,5 | 42,5/36/26/20 | 45/40,5/36/30 |
| Dimensions w/h/d     | net               | mm      | 715/285/194   | 805/285/194       | 957/302/213   | 1040/327/220  |
|                      | transport         | mm      | 780/365/270   | 870/365/270       | 1035/385/295  | 1120/405/315  |
| Weight               | net               | kg      | 6,7           | 7,3               | 10,0          | 12,3          |
|                      | transport         | kg      | 8,8           | 9,5               | 13,0          | 15,8          |
| Pipe diameter        | liquid            | mm      | 6,35          | 6,35              | 6,35          | 9,52          |
|                      | gas               | mm      | 9,52          | 9,52              | 12,70         | 15,90         |



## KLW 09 | 12 | 18 | 24 HRHI / KLB 09 | 12 | 18 | 24 HRHI

WI-FI AS A STANDARD

| MODEL                |                   |         | KLW-09HRHI<br>KLB-09HRHI | KLW-12HRHI<br>KLB-12HRHI | KLW-18HRHI<br>KLB-18HRHI | KLW-24HRHI<br>KLB-24HRHI |
|----------------------|-------------------|---------|--------------------------|--------------------------|--------------------------|--------------------------|
| Power supply         |                   | V/Hz/Ph | 220÷240/50/1             | 220÷240/50/1             | 220÷240/50/1             | 220÷240/50/1             |
| Capacity             | cooling           | kW      | 2,6                      | 3,5                      | 5,3                      | 7,0                      |
|                      | heating           | kW      | 2,9                      | 3,8                      | 5,6                      | 7,3                      |
| Air flow rate        |                   | m³/h    | 510/360/300              | 520/370/310              | 800/600/500              | 1090/770/610             |
| Sound pressure level | (high/medium/low) | dB(A)   | 37/31/22/19              | 39/33/22/21              | 41/37/31/20              | 46/37/34,5/21            |
| Dimensions w/h/d     | net               | mm      | 835x295x208              | 835x295x208              | 969x320x241              | 1083x336x244             |
|                      | transport         | mm      | 905x355x290              | 905x355x290              | 1045x405x315             | 1155x415x315             |
| Weight               | net               | kg      | 8,7                      | 8,7                      | 11,2                     | 13,6                     |
|                      | transport         | kg      | 11,5                     | 11,5                     | 14,6                     | 17,3                     |
| Pipe diameter        | liquid            | mm      | 6,35                     | 6,35                     | 6,35                     | 6,35                     |
|                      | gas               | mm      | 9,52                     | 9,52                     | 12,7                     | 15,9                     |



## KGE-09 | 12 | 18 | 24 GRHI

WI-FI AS A STANDARD

| MODEL                |                   |         | KGE-09GRHI     | KGE-12GRHI   | KGE-18GRHI   | KGE-24GRHI   |
|----------------------|-------------------|---------|----------------|--------------|--------------|--------------|
| Power supply         |                   | V/Hz/Ph | 220÷240/50/1   | 220÷240/50/1 | 220÷240/50/1 | 220÷240/50/1 |
| Capacity             | cooling           | kW      | 2,6            | 3,5          | 5,3          | 7,0          |
|                      | heating           | kW      | 2,9            | 3,8          | 5,6          | 7,3          |
| Air flow rate        |                   | m³/h    | 483/362/303    | 584/477/395  | 730/500/420  | 1020/830/640 |
| Sound pressure level | (high/medium/low) | dB(A)   | 36,5/29,0/24,0 | 39,5/33/25   | 43/33,5/28   | 47/41,5/30,5 |
| Dimensions w/h/d     | net               | mm      | 802/297/189    | 802/297/189  | 965/319/215  | 1080/335/226 |
|                      | transport         | mm      | 875/380/285    | 875/380/285  | 1045/410/305 | 1155/415/320 |
| Weight               | net               | kg      | 8,6            | 8,6          | 10,9         | 13,7         |
|                      | transport         | kg      | 11,1           | 11,1         | 14,2         | 17,3         |
| Pipe diameter        | liquid            | mm      | 6,35           | 6,35         | 6,35         | 9,52         |
|                      | gas               | mm      | 9,52           | 9,52         | 12,70        | 15,90        |



## KTI-18HWG32X



## KFAU-12 | 17 HRG32X

| MODEL                       |                   |         | KTI-18HWG32X |
|-----------------------------|-------------------|---------|--------------|
| Power supply                |                   | V/Hz/Ph | 220÷240/50/1 |
| Capacity                    | cooling           | kW      | 5,3          |
|                             | heating           | kW      | 5,6          |
| Air flow rate               |                   | m³/h    | 911/706/515  |
| Sound pressure level        | (high/medium/low) | dB(A)   | 41/38/34/26  |
| Available compression ratio | factory / max.    | Pa      | 25/100       |
| Dimensions w/h/d            | net               | mm      | 880/210/674  |
|                             | transport         | mm      | 1070/280/725 |
| Weight                      | net               | kg      | 24,4         |
|                             | transport         | kg      | 29,6         |
| Pipe diameter               | liquid            | mm      | 6,35         |
|                             | gas               | mm      | 12,70        |

| MODEL                | KFAU-12HRG32X | KFAU-17HRG32X |
|----------------------|---------------|---------------|
| Power supply         | 220÷240/50/1  | 220÷240/50/1  |
| Capacity             | 3,5           | 5,0           |
|                      | 3,8           | 5,3           |
| Air flow rate        | 650/580/490   | 780/690/600   |
| Sound pressure level | 37/34/27      | 41/38/32      |
| Dimensions w/h/d     | 794/621/206   | 794/621/206   |
|                      | 865/719/280   | 865/719/280   |
| Weight               | 14,9          | 14,9          |
|                      | 18,8          | 18,8          |
| Pipe diameter        | 6,35          | 6,35          |
|                      | 9,52          | 12,7          |



## KCA3I-09HRG32X | KCA4U-12 | 18 HRG32X

| MODEL                 |                   |                   | KCA3I-09HRG32X | KCA4U-12HRG32X    | KCA4U-18HRG32X |
|-----------------------|-------------------|-------------------|----------------|-------------------|----------------|
| Power supply          |                   | V/Hz/Ph           | 220÷240/50/1   | 220÷240/50/1      | 220÷240/50/1   |
| Capacity              | cooling           | kW                | 2,6            | 3,5               | 5,3            |
|                       | heating           | kW                | 2,8            | 3,8               | 5,6            |
| Air flow rate         |                   | m <sup>3</sup> /h | 580/500/450    | 620/520/330       | 660/540/300    |
| Sound pressure level  | (high/medium/low) | dB(A)             | 38/33/29       | 42/38,5/31,5/25,5 | 44/41/31,5/25  |
| Dimensions w/h/d      | net               | mm                | 570/260/570    | 570/245/570       | 570/245/570    |
|                       | transport         | mm                | 662/317/662    | 715/295/640       | 715/295/640    |
| Dimensions w/h/dpanel | net               | mm                | 620/50/620     | 620/50/620        | 647/50/647     |
|                       | transport         | mm                | 715/123/715    | 715/115/700       | 715/115/700    |
| Weight                | net               | kg                | 14,5/2,5       | 16,1/2,7          | 16,2/2,7       |
|                       | transport         | kg                | 17,3/4,5       | 18,8/4,3          | 19/4,3         |
| Pipe diameter         | liquid            | mm                | 6,35           | 6,35              | 6,35           |
|                       | gas               | mm                | 9,52           | 9,52              | 12,70          |

# Outdoor units

| MODEL                                      | outdoor unit    |                   | K20E-18HFN32H                | K30A-27HFN32H                  | K40E-28HFN32H                  | K40B-36HFN32H                  | K50E-42HFN32H                  |
|--|-----------------|-------------------|------------------------------|--------------------------------|--------------------------------|--------------------------------|--------------------------------|
| Capacity average (min÷max)                 | cooling         | kW                | 5,3(2,3÷5,7)                 | 7,9(3,2÷8,2)                   | 8,2(2,0÷9,8)                   | 10,6(2,0÷12,7)                 | 12,3(3,0÷12,3)                 |
|  | heating         | kW                | 5,6(2,4÷5,7)                 | 8,2(2,3÷8,5)                   | 8,8(2,4÷10,6)                  | 10,8(2,3÷13,0)                 | 12,3(3,5÷12,3)                 |
| Energy class                               | cooling/heating |                   | A++/A+                       | A++/A+                         | A++/A                          | A++/A                          | A++/A                          |
| SEER                                       | average         | W/W               | 6,1                          | 6,1                            | 6,1                            | 6,2                            | 6,1                            |
| SCOP                                       | average         | W/W               | 3,8                          | 4,0                            | 3,8                            | 3,8                            | 3,5                            |
| Average power consumption (min÷max)        | cooling         | W                 | 1635(690÷2000)               | 2450(290÷3100)                 | 2540(890÷3180)                 | 3270(1140÷4090)                | 3810(280÷4650)                 |
|  | heating         | W                 | 1500(600÷1780)               | 2210(370÷2900)                 | 2200(770÷2750)                 | 2760(970÷3450)                 | 3300(650÷3800)                 |
| Average operating current (min÷max)        | cooling         | A                 | 7,3(3,2÷9,0)                 | 11,2(2,0÷13,5)                 | 11,3(3,9÷14,1)                 | 14,3(5,1÷18,2)                 | 16(1,4÷20,7)                   |
|  | heating         | A                 | 6,6(2,80÷7,95)               | 10,1(2,4÷13)                   | 9,8(3,4÷12,2)                  | 12,1(4,3÷15,3)                 | 14,6(3,0÷16,6)                 |
| Air flow rate                              |                 | m <sup>3</sup> /h | 2100                         | 3000                           | 3800                           | 4000                           | 3850                           |
| Operating temperature cooling/heating      |                 | °C                | -15+50/-15+24                | -15+50/-15+24                  | -15+50/-15+24                  | -15+50/-15+24                  | -15+50/-15+24                  |
| Sound pressure level                       |                 | dB(A)             | 54                           | 58                             | 61,5                           | 63                             | 64                             |
| Net dimensions w/h/d                       |                 | mm                | 805/554/330                  | 890/673/342                    | 946/810/410                    | 946/810/410                    | 946/810/410                    |
| Transport dimensions w/h/d                 |                 | mm                | 915/615/370                  | 1030/750/438                   | 1090/875/500                   | 1090/875/500                   | 1090/875/500                   |
| Net weight                                 |                 | kg                | 35,0                         | 48,0                           | 62,1                           | 68,8                           | 74,1                           |
| Transport weight                           |                 | kg                | 38                           | 51,8                           | 67,7                           | 75,6                           | 79,5                           |
| Pipe diameter: liquid/gas                  |                 | mm                | 2x 6,35/9,52                 | 3x 6,35/9,52                   | 3x 6,35/9,52<br>+ 1x 6,35/12,7 | 3x 6,35/9,52<br>+ 1x 6,35/12,7 | 4x 6,35/9,52<br>+ 1x 6,35/12,7 |
| Maximum installation length                |                 | m                 | 40                           | 60                             | 80                             | 80                             | 80                             |
| Max. installation length for 1 indoor unit |                 | m                 | 25                           | 30                             | 35                             | 35                             | 35                             |
| Maximum height difference                  |                 | m                 | 15                           | 15                             | 15                             | 15                             | 15                             |
| Power supply                               |                 | V/Hz/Ph           | 220-240/50/1                 | 220-240/50/1                   | 220-240/50/1                   | 220-240/50/1                   | 220-240/50/1                   |
| Circuit breaker/fuse                       |                 | A                 | 16                           | 20                             | 25                             | 25                             | 25                             |
| Power supply lines                         |                 | # of wires        | 3x2,5                        | 3x2,5                          | 3x4,0                          | 3x4,0                          | 3x4,0                          |
| Control lines                              |                 | x mm <sup>2</sup> | 4x1,5                        | 4x1,5                          | 4x1,5                          | 4x1,5                          | 4x1,5                          |
| Factory amount of refrigerant              |                 | kg                | 1,25                         | 1,85                           | 2,10                           | 2,10                           | 2,90                           |
| Additional amount of refrigerant           |                 | g/m               | 12 (powyżej 15 m instalacji) | 12 (powyżej 22,5 m instalacji) | 12 (powyżej 30 m instalacji)   | 12 (powyżej 30 m instalacji)   | 12 (powyżej 37,5 m instalacji) |



# Indoor units

## Configuration table

The table shows possible options for connecting indoor units of different capacities to outdoor units. The figures in the table correspond to the capacity of the units expressed in thousands of BTU/h.

### K2OE-18HFN32H

| 1 UNIT | 2 UNITS |
|--------|---------|
| 9      | 9+9     |
| 12     | 9+12    |
| 18     | 12+12   |

### K3OA-27HFN32H

| 1 UNIT | 2 UNITS | 3 UNITS  |
|--------|---------|----------|
| 9      | 9+9     | 12+12    |
| 12     | 9+12    | 12+18    |
| 18     | 9+18    | 9+9+9    |
|        |         | 12+12+12 |
|        |         | 9+9+12   |
|        |         | 9+12+12  |

### K4OE-28HFN32H

| 1 UNIT | 2 UNITS | 3 UNITS  | 4 UNITS   |
|--------|---------|----------|-----------|
| 9      | 9+9     | 12+12    | 9+9+9     |
| 12     | 9+12    | 12+18    | 9+12+12   |
| 18     | 9+18    | 18+18    | 9+9+9+9   |
| 24     | 9+24    | 12+24    | 9+9+12+12 |
|        |         | 12+12+12 |           |

### K4OB-36HFN32H

| 1 UNIT | 2 UNITS | 3 UNITS | 4 UNITS     |
|--------|---------|---------|-------------|
| 9      | 9+9     | 12+24   | 9+9+9       |
| 12     | 9+12    | 24+9    | 9+18+18     |
| 18     | 9+18    |         | 9+12+24     |
| 24     | 12+12   | 9+9+24  | 12+12+12    |
|        | 12+18   | 9+12+12 | 9+9+9+18    |
|        | 18+18   | 9+12+18 | 9+9+12+12   |
|        |         |         | 9+12+12+12  |
|        |         |         | 12+12+12+12 |

### K5OE-42HFN32H

| 1 UNIT    | 2 UNITS     | 3 UNITS      |
|-----------|-------------|--------------|
| 9         | 9+9         | 12+12        |
| 12        | 9+12        | 12+18        |
| 18        | 9+18        | 12+24        |
| 24        | 9+24        | 18+18        |
|           |             | 9+9+9        |
|           |             | 9+12+12      |
|           |             | 12+12+12     |
|           |             | 9+9+12       |
|           |             | 9+12+18      |
|           |             | 12+12+18     |
|           |             | 9+9+18       |
|           |             | 9+12+24      |
|           |             | 12+12+24     |
|           |             | 9+9+24       |
|           |             | 9+18+18      |
|           |             | 12+18+18     |
| 4 UNITS   | 5 UNITS     |              |
| 9+9+9+9   | 9+9+12+18   | 12+12+12+18  |
| 9+9+9+12  | 9+9+18+24   | 9+9+9+9+9    |
| 9+9+9+18  | 9+12+12+12  | 9+9+9+9+12   |
| 9+9+9+24  | 9+12+12+18  | 9+9+9+9+18   |
| 9+9+12+12 | 12+12+12+12 | 9+9+9+12+12  |
|           |             | 9+9+12+12+12 |

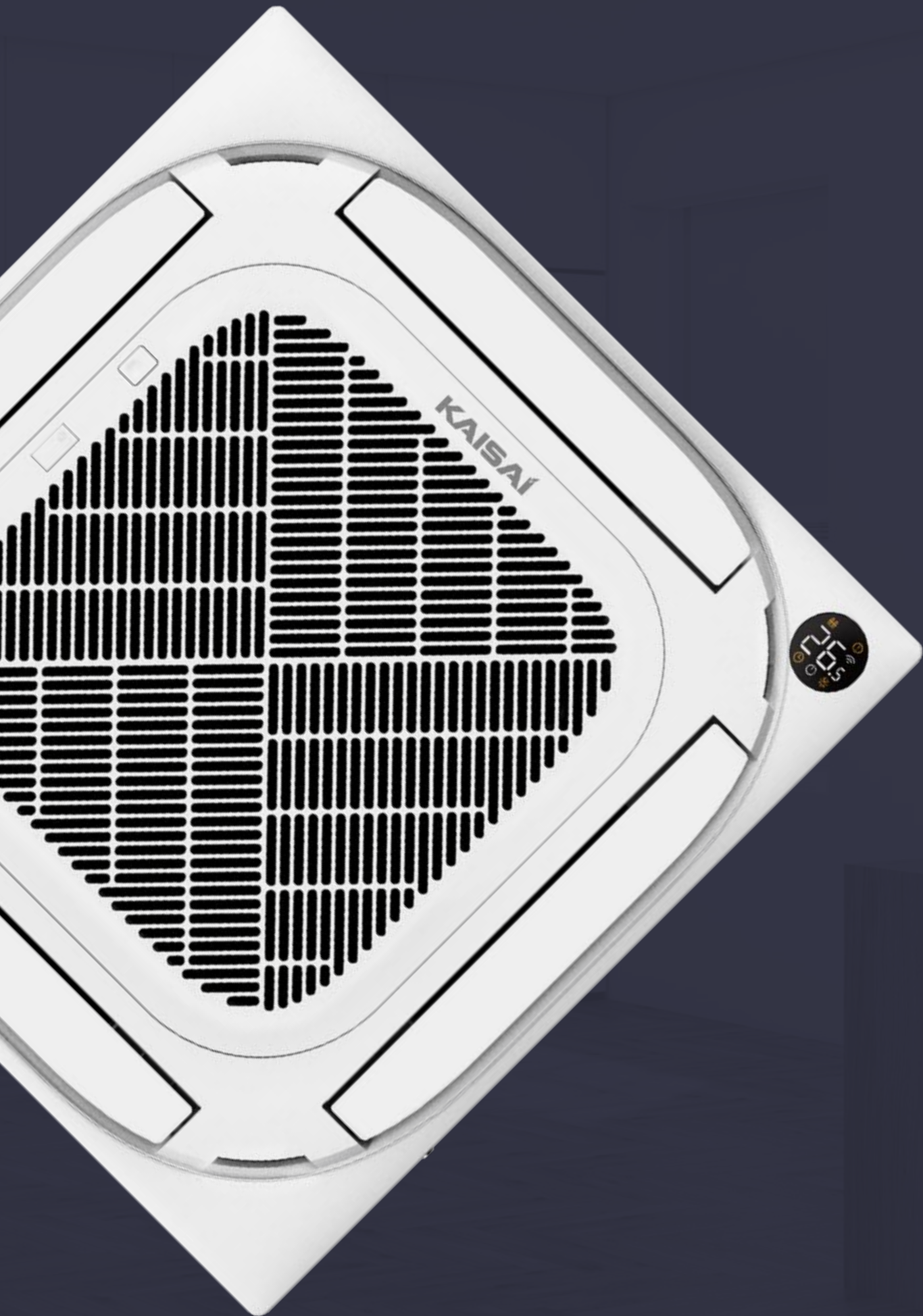

floor

floor and ceiling

console

cassette

duct

condensing units

# Commercial air conditioners

**Commercial air conditioning systems combine efficient operation with a wide range of solutions for offices, conference rooms, hotels and other rooms that require efficient air conditioning.**

Depending on the area and purpose of the facility, as well as the installation possibilities, we can apply floor, floor/ceiling, cassette, duct, or condensing units.



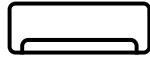

KFS-24HRG32X

**NEW  
2024**

# kfs-24

The new floor standing air conditioner model is ideal for rooms of 60-70 m<sup>2</sup>, such as offices, lounges or conference rooms.

In addition to traditional control via a wireless remote control, the KFS-24 air conditioner also offers a modern touch panel built into the unit. This makes use even more convenient and intuitive, allowing quick and precise control of various functions and parameter settings. The VLED display adds style to the panel and makes the digits easy to read from any angle. Thanks to the extended and widened air outlet, the air conditioner provides even cooling throughout the room for exceptional thermal comfort.

**A<sup>+</sup>** | **R32**





## Features of **Kaisai KFS**



Wide temperature range

**OPTIONAL**



Silver ion filter



3D air supply

**OPTIONAL**



Vitamin C filter



Automatic blinds (swing)

**OPTIONAL**



3M filter



Refrigerant leakage indication



Cold air control



Remote control temperature sensor



Sleep function



Timer



Automatic restart



Self-diagnosis



Electronic expansion valve



Operation at low outside temperatures

## Technical specification

| MODEL                                 | indoor unit     | KFS-24HRG32X     |                 |
|---------------------------------------|-----------------|------------------|-----------------|
|                                       | outdoor unit    | KOX430L-24HFN32X |                 |
| Capacity average (min÷max)            | cooling         | kW               | 7,0 (2,3-7,9)   |
|                                       | heating         | kW               | 7,6 (3,6-8,6)   |
| Energy class                          | cooling/heating |                  | A++ / A+        |
| SEER                                  | average         | W/W              | 6,3             |
| SCOP                                  | average         | W/W              | 4,1             |
| Average power consumption (min÷max)   | cooling         | W                | 2200 (570~2800) |
|                                       | heating         | W                | 2180 (700~2745) |
| Average operating current (min÷max)   | cooling         | A                | 9,8 (2,5~12,4)  |
|                                       | heating         | A                | 9,7 (3,10~12,2) |
| Air flow rate                         | indoor          | m³/h             | 1050/800/670    |
|                                       | outdoor         | m³/h             | 3500            |
| Operating temperature cooling/heating | indoor          | °C               | 17÷32/0÷30      |
|                                       | outdoor         | °C               | -15÷50/-15÷24   |
| Sound pressure level                  | indoor          | dB(A)            | 45/40/37/32     |
|                                       | outdoor         | dB(A)            | 59,5            |
| Net dimensions w/h/d                  | indoor          | mm               | 405x405x1775    |
|                                       | outdoor         | mm               | 490x510x2000    |
| Transport dimensions w/h/d            | indoor          | mm               | 29,1            |
|                                       | outdoor         | mm               | 38,3            |
| Net weight                            | indoor          | kg               | 890x342x673     |
|                                       | outdoor         | kg               | 995x398x740     |
| Transport weight                      | indoor          | kg               | 43,8            |
|                                       | outdoor         | kg               | 46,8            |
| Pipe diameter: liquid/gas             |                 | mm               | 6,35/12,7       |
| Maximum installation length           |                 | m                | 50              |
| Maximum height difference             |                 | m                | 25              |
| Power supply                          | outdoor         |                  | 220-240, 50, 1  |
| Circuit breaker/fuse                  | outdoor         | A                | 20              |
| Power supply lines                    | outdoor         | # of wires x mm² | 3x2,5           |
| Control lines                         | ind. - outd.    |                  | 4x1,5           |
| Factory amount of refrigerant         | up to 5 rm      | kg               | 1,13            |
| Additional amount of refrigerant      | over 5 rm       | g/m              | 12              |

## Controllers

WIRELESS  
REMOTE CONTROL

**RG10B**







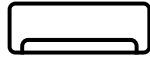

KFS-48HRG32X

# kfs

**The floor air conditioner is used in large rooms, such as stores, showrooms, restaurants and airport halls.**

The KFS air conditioner is distinguished by an elegant and intuitive control panel, a functional wireless remote control with temperature sensor and energy saving technology, allowing the unit to operate in economy mode. The comfort of use is ensured by practical functions of the air conditioner, such as: 3D airflow for uniform temperature distribution in the room and the temperature sensor built in the remote control (thanks to which the temperature is measured where the user is located, and the operation of the air conditioner is adjusted to the actual conditions in the room). The device can be used in rooms of up to approx. 120-140 m<sup>2</sup>.

**A<sup>+</sup> | R32**





## Features of **Kaisai KFS**



Wide temperature range



Silver ion filter



3D air supply



Vitamin C filter



Automatic blinds (swing)



3M filter



Refrigerant leakage indication



Cold air control



Remote control temperature sensor



Sleep function



Timer



Automatic restart



Self-diagnosis



Electronic expansion valve



Operation at low outside temperatures

## Technical specification

| MODEL                                 | indoor unit     | KFS-48HRG32X     |                 |
|---------------------------------------|-----------------|------------------|-----------------|
|                                       | outdoor unit    | KOE30U-48HFN32X  |                 |
| Capacity average (min÷max)            | cooling         | kW               | 14,1(3,5÷15,7)  |
|                                       | heating         | kW               | 16,1(4,1÷17,9)  |
| Energy class                          | cooling/heating |                  | A++/A+          |
| SEER                                  | average         | W/W              | 6,1             |
| SCOP                                  | average         | W/W              | 4               |
| Average power consumption (min÷max)   | cooling         | W                | 4950(900÷5950)  |
|                                       | heating         | W                | 5100(1000÷6200) |
| Average operating current (min÷max)   | cooling         | A                | 8,0(1,9÷10,3)   |
|                                       | heating         | A                | 8,5(1,6÷10,5)   |
| Air flow rate                         | indoor          | m³/h             | 2413/2222/2027  |
|                                       | outdoor         | m³/h             | 7500            |
| Operating temperature cooling/heating | indoor          | °C               | 17÷32/0÷30      |
|                                       | outdoor         | °C               | -15÷50/-15÷24   |
| Sound pressure level                  | indoor          | dB(A)            | 53/49/47        |
|                                       | outdoor         | dB(A)            | 63,5            |
| Net dimensions w/h/d                  | indoor          | mm               | 629/1935/456    |
|                                       | outdoor         | mm               | 952/1333/415    |
| Transport dimensions w/h/d            | indoor          | mm               | 750/2055/575    |
|                                       | outdoor         | mm               | 1095/1480/495   |
| Net weight                            | indoor          | kg               | 59,0            |
|                                       | outdoor         | kg               | 103,7           |
| Transport weight                      | indoor          | kg               | 77,0            |
|                                       | outdoor         | kg               | 118,3           |
| Pipe diameter: liquid/gas             |                 | mm               | 9,52/15,9       |
| Maximum installation length           |                 | m                | 75              |
| Maximum height difference             |                 | m                | 30              |
| Power supply                          | outdoor         |                  | 380-420/50/3    |
| Circuit breaker/fuse                  | outdoor         | A                | 16              |
| Power supply lines                    | outdoor         | # of wires x mm² | 5x2,5           |
| Control lines                         | ind. - outd.    |                  | 4 x 1,5         |
| Factory amount of refrigerant         | up to 5 rm      | kg               | 2,9             |
| Additional amount of refrigerant      | over 5 rm       | g/m              | 24              |
| Outer diameter of condensate drain    |                 | mm               | 25              |

## Controllers

WIRELESS  
REMOTE CONTROL

**RG10B**





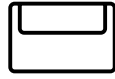

KUE 18|24|36|48|55 HRG32X

# kue

**Universal floor/ceiling air conditioners, which are perfect for rooms without false ceilings, among others.**

They are characterised by a three-dimensional air flow thanks to the automatic control of the blinds. This ensures optimum air circulation and even temperature distribution. The timer allows you to set a time for the automatic activation and deactivation of the air conditioner. To minimise the feeling of unpleasant, cold air, the air conditioner starts in heating mode and automatically reduces the fan speed – until the heat exchanger heats up.

**A<sup>+</sup> | R32**





## Features of **Kaisei KUE**



Blinds settings memory



**Turbo**  
Turbo mode



Double sided installation



Refrigerant leakage indication



Built-in condensate pump



Quiet operation



Alarm port



Emergency use



Timer



Automatic restart



Naview 3D



Compressor and condensate tray heaters



Twin combination



Fresh air



On-off port



Gear mode



The Eco Mode



Sleep function



Heating function 8°C



Self-cleaning evaporator



Cold air control



Remote control temperature sensor



Smooth fan speed adjustment



Electronic expansion valve



Operation at low outside temperatures



**OPTIONAL**  
Central controller



**OPTIONAL**  
Wi-Fi control



**OPTIONAL**  
Wired controller



**OPTIONAL**  
Silver ion filter



**OPTIONAL**  
Vitamin C filter



**OPTIONAL**  
3M filter

## Technical specification

| MODEL                              | indoor unit     |            | KUE-18HRG32X     | KUE-24HRG32X     | KUE-36HRG32X    | KUE-36HRG32X     | KUE-48HRG32X     | KUE-55HRG32X     |
|------------------------------------|-----------------|------------|------------------|------------------|-----------------|------------------|------------------|------------------|
|                                    | outdoor unit    |            | KOX330-18HF-N32X | KOX430-24HF-N32X | KOD30U-36HFJ32X | KOD30U-36HF-N32X | KOE30U-48HF-N32X | KOE30U-55HF-N32X |
| Capacity average (min÷max)         | cooling         | kW         | 5,3 (2,7÷5,9)    | 7,0 (3,2÷7,8)    | 10,6 (2,7÷11,4) | 10,6 (2,7÷11,8)  | 14,1 (3,5÷15,2)  | 15,8 (4,1÷16,7)  |
|                                    | heating         | kW         | 5,6 (2,4÷6,3)    | 7,6 (2,7÷8,3)    | 11,7 (2,8÷12,8) | 11,7 (2,8÷12,8)  | 16,1 (4,1÷17,0)  | 18,2 (4,4÷19,6)  |
| Energy class                       | cooling/heating |            | A++/A+           | A++/A+           | A++/A+          | A++/A+           | A++/A+           | A++/A+           |
| SEER                               | average         | W/W        | 6,2              | 6,1              | 6,2             | 6,4              | 6,1              | 6,1              |
| SCOP                               | average         | W/W        | 4,0              | 4,0              | 4,0             | 4,1              | 4,0              | 4,0              |
| Avg. power consumption (min÷max)   | cooling         | W          | 1450 (670÷2027)  | 2300 (747÷2930)  | 3900 (900÷4250) | 40000 (890÷4300) | 5000 (900÷5950)  | 5650 (1100÷6650) |
|                                    | heating         | W          | 1500 (540÷1640)  | 2050 (650÷2850)  | 3350 (800÷3950) | 3350 (780÷3950)  | 5100 (1000÷6050) | 6050 (1050÷7100) |
| Avg. operating current (min÷max)   | cooling         | A          | 6,0 (3,2÷9,0)    | 10,5 (3,9÷13,1)  | 17,0 (4,2÷19,0) | 6,3 (1,4÷6,8)    | 8,8 (1,9÷10,3)   | 9,7 (3,2÷11,5)   |
|                                    | heating         | A          | 6,6 (2,7÷7,3)    | 9,5 (3,5÷12,7)   | 15,0 (3,5÷17,5) | 5,4 (1,3÷6,2)    | 8,9 (2,1÷10,5)   | 10,5 (2,2÷12,0)  |
| Air flow rate                      | indoor          | m³/h       | 958/839/723      | 1192/1023/853    | 1955/1728/1504  | 1955/1728/1504   | 2100/1850/1600   | 2200/1950/1650   |
|                                    | outdoor         | m³/h       | 2200             | 3500             | 4000            | 4000             | 7500             | 7500             |
| Operating temp. cooling/heating    | indoor          | °C         | 16÷32/0÷30       | 16÷32/0÷30       | 16÷32/0÷30      | 16÷32/0÷30       | 16÷32/0÷30       | 16÷32/0÷30       |
|                                    | outdoor         | °C         | -15+50/-15+24    | -15+50/-15+24    | -15+50/-15+24   | -15+50/-15+24    | -15+50/-15+24    | -15+50/-15+24    |
| Sound pressure level               | indoor          | dB(A)      | 43,5/41/36,5/24  | 49/46/43/32      | 50/48,5/44/37   | 50/48,5/44/37    | 53/50/45/36      | 54/50,5/46,5/38  |
|                                    | outdoor         | dB(A)      | 56               | 60               | 63              | 63               | 63,5             | 64               |
| Net dimensions w/h/d               | indoor          | mm         | 1068/675/235     | 1068/675/235     | 1650/675/235    | 1650/675/235     | 1650/675/235     | 1650/675/235     |
|                                    | outdoor         | mm         | 805/554/330      | 890/673/342      | 946/810/410     | 946/810/410      | 952/1333/415     | 952/1333/415     |
| Transp. dimensions w/h/d           | indoor          | mm         | 1145/755/318     | 1145/755/318     | 1725/755/318    | 1725/755/318     | 1725/755/318     | 1725/755/318     |
|                                    | outdoor         | mm         | 915/615/370      | 995/740/398      | 1090/885/500    | 1090/885/500     | 1095/1480/495    | 1095/1480/495    |
| Net weight                         | indoor          | kg         | 28,0             | 28,0             | 41,5            | 41,5             | 41,7             | 42,3             |
|                                    | outdoor         | kg         | 26,6             | 43,9             | 66,9            | 80,5             | 103,7            | 107,0            |
| Transport weight                   | indoor          | kg         | 33,1             | 33,3             | 48,0            | 48,0             | 48,5             | 49,2             |
|                                    | outdoor         | kg         | 29,0             | 46,9             | 71,5            | 85,0             | 118,3            | 121,2            |
| Pipe diameter: liquid/gas          | mm              |            | 6,35/12,7        | 9,52/15,9        | 9,52/15,9       | 9,52/15,9        | 9,52/15,9        | 9,52/15,9        |
| Maximum installation length        | m               |            | 30               | 50               | 75              | 75               | 75               | 75               |
| Maximum height difference          | m               |            | 20               | 25               | 30              | 30               | 30               | 30               |
| Power supply                       | outdoor         | V/Hz/Ph    | 220÷240/50/1     | 220÷240/50/1     | 220÷240/50/1    | 380÷420/50/3     | 380÷420/50/3     | 380÷420/50/3     |
| Circuit breaker/fuse               | outdoor         | A          | 16               | 20               | 25              | 16               | 16               | 16               |
| Power supply lines                 | outdoor         | # of wires | 3x2,5            | 3x2,5            | 3x4,0           | 5x2,5            | 5x2,5            | 5x2,5            |
| Control lines                      | ind. - outd.    | x mm²      | 4x1,5            | 4x1,5            | 4x1,5           | 4x1,5            | 4x1,5            | 4x1,5            |
| Factory amount of                  | up to 5 rm      | kg         | 1,15             | 1,5              | 2,4             | 2,4              | 2,9              | 3,0              |
| Additional refrigerant             | over 5 rm       | g/m        | 12               | 24               | 24              | 24               | 24               | 24               |
| Outer diameter of condensate drain | mm              |            | 25               | 25               | 25              | 25               | 25               | 25               |

## Controllers

WIRELESS  
REMOTE CONTROL



**RG10A**

WIRED REMOTE  
CONTROL



**KJR-120X2  
(OPTIONAL)**

WIRED REMOTE  
CONTROL



**KJR-120N  
(OPTIONAL)**

WIRED REMOTE  
CONTROL



**CCM  
(OPTIONAL)**





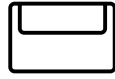

KFAU 12 | 17 HRG32X

# console

**The console air conditioner is a solution designed to be installed in the skirting area, leaving the wall space free.**

























Thanks to its design, which allows the air to flow both up and down, it can be used in rooms where it is not possible to install wall units: in attics, in rooms with sloping roofs and in recesses under windows. Thanks to the movable supply fins and their wide angle of inclination, the console provides efficient and effective air distribution throughout the room.

**A<sup>+</sup> | R32**





## Features of Kaisai CONSOLE

|   |   |   |   |   |   |   |   |  |   |   |   |   |
|---|---|---|---|---|---|---|---|--|---|---|---|---|
|  |  |  |  |  |  |  |  |  |  |  |  |  |
| Blinds settings memory  | Turbo mode  | Double sided installation   | Refrigerant leakage indication  | Remote control temperature sensor   | Compressor & condensate tray heaters  | Timer   | Emergency use   | Automatic restart  | 3D air flow   | Mono & multi  | Electronic expansion valve  | Operation at low outside temperatures   |
|  |  |  |  |  |  |  |  |  |  |  |  |   |
| Gear mode   | The Eco Mode  | Sleep function  | Heating function 8°C  | Self-cleaning evaporator  | Cold air control  | Quiet operation   | Smooth fan speed adjustment   | Wi-Fi control  | Silver ion filter   | Vitamin C filter  | 3M filter   |   |

## Technical specification

| MODEL                                 | indoor unit     |                   | KFAU-12HRG32X   | KFAU-17HRG32X   |
|---------------------------------------|-----------------|-------------------|-----------------|-----------------|
|                                       | outdoor unit    |                   | KOX230-12HFN32X | KOX330-18HFN32X |
| Capacity average (min÷max)            | cooling         | kW                | 3,5(0,8÷4,2)    | 5,0(2,6÷5,6)    |
|                                       | heating         | kW                | 3,8(0,4÷4,7)    | 5,3(2,2÷6,3)    |
| Energy class                          | cooling/heating |                   | A++/A+          | A++/A+          |
| SEER                                  | average         | W/W               | 7,3             | 6,7             |
| SCOP                                  | average         | W/W               | 4,0             | 4,0             |
| Average power consumption (min÷max)   | cooling         | W                 | 1000(170÷1350)  | 1500(650÷1950)  |
|                                       | heating         | W                 | 980(150÷1300)   | 1420(600÷1900)  |
| Average operating current (min÷max)   | cooling         | A                 | 4,5(1,4÷5,9)    | 6,7(3,0÷8,7)    |
|                                       | heating         | A                 | 4,4(1,2÷6,0)    | 6,4(2,7÷8,5)    |
| Air flow rate                         | indoor          | m <sup>3</sup> /h | 650/580/490     | 780/690/600     |
|                                       | outdoor         | m <sup>3</sup> /h | 2100            | 2200            |
| Operating temperature cooling/heating | indoor          | °C                | 16÷32/0÷30      | 16÷32/0÷30      |
|                                       | outdoor         | °C                | -15÷50/-15÷24   | -15÷50/-15÷24   |
| Sound pressure level                  | indoor          | dB(A)             | 37/34/27        | 41/38/32        |
|                                       | outdoor         | dB(A)             | 53,6            | 56,0            |
| Net dimensions w/h/d                  | indoor          | mm                | 794/621/206     | 794/621/206     |
|                                       | outdoor         | mm                | 765/555/303     | 805/554/330     |
| Transport dimensions w/h/d            | indoor          | mm                | 865/719/280     | 865/719/280     |
|                                       | outdoor         | mm                | 887/610/337     | 915/615/370     |
| Net weight                            | indoor          | kg                | 14,9            | 14,9            |
|                                       | outdoor         | kg                | 26,6            | 32,5            |
| Transport weight                      | indoor          | kg                | 18,8            | 18,8            |
|                                       | outdoor         | kg                | 29,0            | 35,2            |
| Pipe diameter: liquid/gas             |                 | mm                | 6,35/9,52       | 6,35/12,7       |
| Maximum installation length           |                 | m                 | 25              | 30              |
| Maximum height difference             |                 | m                 | 10              | 20              |
| Power supply                          | outdoor         |                   | 220-240/50/1    | 220-240/50/1    |
| Circuit breaker/fuse                  | outdoor         | A                 | 16              | 16              |
| Power supply lines                    | outdoor         | # of wires x      | 3x2,5           | 3x2,5           |
| Control lines                         | ind. - outd.    | mm <sup>2</sup>   | 4x1,5           | 4x1,5           |
| Factory amount of refrigerant         | up to 5 m       | kg                | 0,72            | 1,15            |
| Additional amount of refrigerant      | over 5 m        | g/m               | 12              | 12              |
| Outer diameter of condensate drain    |                 | mm                | 25              |                 |

## Controllers

WIRELESS  
REMOTE CONTROL

RG10A





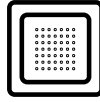

KCA4U 12 | 18 HRG32X

**NEW  
2024**

# kca

**Cassette air conditioners are perfect for offices, conference rooms, or any other space requiring efficient air conditioning.**

Compared to the previous Compact series of cassette air conditioners, the dimensions of the panel and indoor unit have been reduced. In addition, the panel was equipped with an elegant temperature display. The lift height of the condensate pump has been increased to 100 cm.



**A<sup>+</sup>**

**R32**



## Features of Kaisai KCA



Blinds settings memory



Fresh air



360° air supply



Refrigerant leakage indication



Sleep function



Quiet operation



Emergency use



Timer



Automatic restart



Alarm port



Self-diagnosis



Electronic expansion valve



Operation at low outside temperatures



The Eco Mode



Turbo mode



Gear mode



Heating function 8°C



Built-in condensate pump



Remote control temperature sensor



Temperature compensation



Twin combination



On-off port



Self-cleaning evaporator



Smooth fan speed adjustment



Cold air control



Compressor and condensate tray heaters



Function Vane



Central controller



Wi-Fi control



Wired controller

## Technical specification

| MODEL                                 | indoor unit     |                  | KCA4U-12HRG32X    | KCA4U-18HRG32X  |
|---------------------------------------|-----------------|------------------|-------------------|-----------------|
|                                       | outdoor unit    |                  | KOX230-12HFN32X   | KOX330-18HFN32X |
| Capacity average (min÷max)            | cooling         | kW               | 3,5 (0,8÷4,1)     | 5,3 (2,9÷5,9)   |
|                                       | heating         | kW               | 3,8 (0,5÷4,3)     | 5,6 (2,4÷6,3)   |
| Energy class                          | cooling/heating |                  | A++/A+            | A++/A+          |
| SEER                                  | average         |                  | W/W 6,8           | 6,5             |
| SCOP                                  | average         |                  | W/W 4,1           | 4,1             |
| Average power consumption (min÷max)   | cooling         | W                | 1015 (160÷1450)   | 1550 (720÷2040) |
|                                       | heating         | W                | 1020 (125÷1390)   | 1560 (700÷1950) |
| Average operating current (min÷max)   | cooling         | A                | 4,5 (1,3÷6,4)     | 6,9 (3,2÷9,0)   |
|                                       | heating         | A                | 4,5 (1,1÷6,2)     | 6,8 (3,1÷8,6)   |
| Air flow rate                         | indoor          | m³/h             | 620/520/330       | 660/540/300     |
|                                       | outdoor         | m³/h             | 2100              | 2200            |
| Operating temperature cooling/heating | indoor          | °C               | 16÷32/0÷30        | 16÷32/0÷30      |
|                                       | outdoor         | °C               | -15÷50/-15÷24     | -15÷50/-15÷24   |
| Sound pressure level                  | indoor          | dB(A)            | 42/38,5/31,5/25,5 | 44/41/31,5/25   |
|                                       | outdoor         | dB(A)            | 57                | 58              |
| Net dimensions w/h/d                  | indoor          | mm               | 570/245/570       | 570/245/570     |
|                                       | outdoor         | mm               | 620/50/620        | 620/50/620      |
|                                       | panel           | mm               | 765/555/303       | 805/554/330     |
| Transport dimensions w/h/d            | indoor          | mm               | 715/295/640       | 715/295/640     |
|                                       | outdoor         | mm               | 715/115/700       | 715/115/700     |
|                                       | panel           | mm               | 887/610/337       | 915/615/370     |
| Net weight                            | indoor          | kg               | 16,1/2,7          | 16,2/2,7        |
|                                       | outdoor         | kg               | 26,6              | 32,5            |
| Transport weight                      | indoor          | kg               | 18,8/4,3          | 19/4,3          |
|                                       | outdoor         | kg               | 29,0              | 35,2            |
| Pipe diameter: liquid/gas             |                 | mm               | 6,35/9,52         | 6,35/12,7       |
| Maximum installation length           |                 | m                | 25                | 30              |
| Maximum height difference             |                 | m                | 10                | 20              |
| Power supply                          | outdoor         | V/Hz/Ph          | 220÷240/50/1      | 220÷240/50/1    |
| Circuit breaker/fuse                  | outdoor         | A                | 16                | 16              |
| Power supply lines                    | outdoor         | # of wires x mm² | 3x2,5             | 3x2,5           |
| Control lines                         | ind. - outd.    | # of wires x mm² | 4x1,5             | 4x1,5           |
| Factory amount of refrigerant         | up to 5 rm      | kg               | 0,72              | 1,15            |
| Additional amount of refrigerant      | over 5 rm       | g/m              | 12                | 12              |
| External diameter of condensate drain |                 | mm               | 25                | 25              |

## Controllers

WIRELESS REMOTE CONTROL



**RG10N2**

WIRED REMOTE CONTROL



**KJR12B (OPTIONAL)**

WIRED REMOTE CONTROL



**KJR-120X2 (OPTIONAL)**

WIRED REMOTE CONTROL



**KJR-120N (OPTIONAL)**

WIRED REMOTE CONTROL



**CCM (OPTIONAL)**





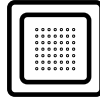

KCD 24 | 36 | 48 | 55 HRG32X

# kcd

**Air conditioners that are ideal for suspended ceilings with particularly limited technical space.**

The air gap area has been increased by 23%, making the air conditioner quieter and more efficient. Compared to the previous model, the height of the condensate pump lift has also been increased to 100 cm and its placement outside the unit makes maintenance or potential replacement much easier. A new feature is the Wi-Fi port built into the air conditioner, allowing you to control the unit via an app on your phone or tablet.

































**A<sup>+</sup>**

**R32**



## Features of **Kaisai KCD**

|   |   |   |   |   |   |   |   |  |   |   |   |
|---|---|---|---|---|---|---|---|--|---|---|---|
|  |  |  |  |  |  |  |  |  |  |  |  |
| Blinds settings memory  | Fresh air   | 360° air supply   | Refrigerant leakage indication  | Sleep function  | Cold air control  | Emergency use   | Timer   | Automatic restart  | Alarm port  | Self-diagnosis  | Operation at low outside temperatures   |
|  |  |  |  |  |  |  |  |  |  |  |  |
| Twin combination  | Turbo mode  | Gear mode   | The Eco Mode  | On-off port   | Quiet operation   | Temperature compensation  | Remote control temperature sensor   | Built-in condensate pump   | Self-cleaning evaporator  | Smooth fan speed adjustment   | Compressor and condensate tray heaters  |
|  |  |  |  |  |  |  |   |  |   |   |   |
| Heating function 8°C  | Wi-Fi control   | Function Vane   | Breeze Away function  | Electronic expansion valve  | Central controller  | Wired controller  |   |  |   |   |   |

## Technical specification

| MODEL                                 | indoor unit     |                   | KCD-24HRG32X      | KCD-36HRG32X    | KCD-36HRG32X     | KCD-48HRG32X      | KCD-55HRG32X     |
|---------------------------------------|-----------------|-------------------|-------------------|-----------------|------------------|-------------------|------------------|
|                                       | outdoor unit    |                   | KOX430-24HF-N32X  | KOD30U-36HFJ32X | KOD30U-36HF-N32X | KOE30U-48HF-N32X  | KOE30U-55HF-N32X |
| Capacity average (min÷max)            | cooling         | kW                | 7,0(3,3÷7,9)      | 10,6(2,7÷11,4)  | 10,6(2,7÷11,4)   | 14,1(3,5÷15,8)    | 15,2(4,1÷16,7)   |
|                                       | heating         | kW                | 7,6(2,8÷8,9)      | 11,1(2,8÷12,0)  | 11,1(2,8÷12,7)   | 16,1(4,1÷17,3)    | 18,2(4,4÷19,9)   |
| Energy class                          | cooling/heating |                   | A++/A+            | A++/A+          | A++/A+           | A++/A+            | A++/A+           |
| SEER                                  | average         | W/W               | 6,2               | 6,7             | 6,4              | 6,1               | 6,3              |
| SCOP                                  | average         | W/W               | 4,0               | 4,0             | 4,0              | 4,0               | 4,0              |
| Average power consumption (min÷max)   | cooling         | W                 | 2320 (780÷2748)   | 3950 (900÷4200) | 4000 (890÷4150)  | 4650 (800÷5900)   | 5000 (980÷6200)  |
|                                       | heating         | W                 | 1900 (610÷2700)   | 3000 (800÷3950) | 3000 (780÷4000)  | 4580 (900÷5500)   | 5550 (1020÷6700) |
| Average operating current (min÷max)   | cooling         | A                 | 10,2(4,2÷12,0)    | 17,5 (4,2÷18,5) | 6,5 (1,4÷6,5)    | 8,1 (1,8÷10,2)    | 8,6 (2,1÷10,7)   |
|                                       | heating         | A                 | 8,5 (3,6÷12,1)    | 13,5 (3,5÷17,5) | 5,0 (1,3÷6,4)    | 8,0 (1,9÷9,5)     | 9,6 (2,1÷10,7)   |
| Air flow rate                         | indoor          | m <sup>3</sup> /h | 1300/1140/1000    | 1700/1550/1380  | 1800/1600/1400   | 1970/1780/1580    | 2000/1850/1650   |
|                                       | outdoor         | m <sup>3</sup> /h | 3500              | 4000            | 4000             | 7500              | 7500             |
| Operating temp. cooling/heating       | indoor          | °C                | 16÷32/0÷30        | 16÷32/0÷30      | 16÷32/0÷30       | 16÷32/0÷30        | 16÷32/0÷30       |
|                                       | outdoor         | °C                | -15+50/-15+24     | -15+50/-15+24   | -15+50/-15+24    | -15+50/-15+24     | -15+50/-15+24    |
| Sound pressure level                  | indoor          | dB(A)             | 45,5/42,5/39,5/27 | 50/47,5/44,5/39 | 50/47,5/44,5/39  | 51/48,5/46,5/37,5 | 53/50,5/48/40    |
|                                       | outdoor         | dB(A)             | 60                | 63              | 63               | 63,5              | 64               |
| Net dimensions w/h/d                  | indoor          | mm                | 830/205/830       | 830/245/830     | 830/245/830      | 830/287/830       | 830/287/830      |
|                                       | outdoor         | mm                | 950/55/950        | 950/55/950      | 950/55/950       | 950/55/950        | 950/55/950       |
|                                       | panel           | mm                | 890/673/342       | 946/810/410     | 946/810/410      | 952/1333/415      | 952/1333/415     |
| Transport dimensions w/h/d            | indoor          | mm                | 910/250/910       | 910/290/910     | 910/290/910      | 910/330/910       | 910/330/910      |
|                                       | outdoor         | mm                | 1035/90/1035      | 1035/90/1035    | 1035/90/1035     | 1035/90/1035      | 1035/90/1035     |
|                                       | panel           | mm                | 995/740/398       | 1090/885/500    | 1090/885/500     | 1095/1480/495     | 1095/1480/495    |
| Net weight                            | indoor          | kg                | 21,6/6,0          | 27,2/6,0        | 27,2/6,0         | 29,3/6,0          | 29,3/6,0         |
|                                       | outdoor         | kg                | 43,9              | 66,9            | 80,5             | 103,7             | 107,0            |
| Transport weight                      | indoor          | kg                | 25,4/9,0          | 31,2/9,0        | 31,2/9,0         | 33,5/9,0          | 33,5/9,0         |
|                                       | outdoor         | kg                | 46,9              | 71,5            | 85,0             | 118,3             | 121,2            |
| Pipe diameter: liquid/gas             |                 | mm                | 9,52/15,9         | 9,52/15,9       | 9,52/15,9        | 9,52/15,9         | 9,52/15,9        |
| Maximum installation length           |                 | m                 | 50                | 75              | 75               | 75                | 75               |
| Maximum height difference             |                 | m                 | 25                | 30              | 30               | 30                | 30               |
| Power supply                          | outdoor         | V/Hz/Ph           | 220÷240/50/1      | 220÷240/50/1    | 380÷420/50/3     | 380÷420/50/3      | 380÷420/50/3     |
| Circuit breaker/fuse                  | outdoor         | A                 | 20                | 25              | 16               | 16                | 16               |
| Power supply lines                    | outdoor         | # of wires        | 3x2,5             | 3x4,0           | 5x2,5            | 5x2,5             | 5x2,5            |
| Control lines                         | ind. - outd.    | x mm <sup>2</sup> | 4x1,5             | 4x1,5           | 4x1,5            | 4x1,5             | 4x1,5            |
| Factory amount of refrigerant         | up to 5 rm      | kg                | 1,5               | 2,4             | 2,4              | 2,9               | 3,0              |
| Additional amount of refrigerant      | over 5 rm       | g/m               | 24                | 24              | 24               | 24                | 24               |
| External diameter of condensate drain |                 | mm                | 25                | 25              | 25               | 25                | 25               |

## Controllers

WIRELESS  
REMOTE CONTROL



**RG10N2**

WIRED REMOTE  
CONTROL



**KJR-120X2  
(OPTIONAL)**

WIRED REMOTE  
CONTROL



**KJR-120N  
(OPTIONAL)**

WIRED REMOTE  
CONTROL



**CCM  
(OPTIONAL)**



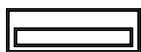

KTI 18 | 24 | 36 | 48 | 55 HWG32X

# k<sup>t</sup>i

**Duct air conditioners are used in buildings with large areas. Their advantage lies in the ability to freely distribute air through the ducts and air in-takes in the entire false ceiling space.**

Slim series duct air conditioners are characterised by a high external static pressure – 160 Pa, while maintaining a low level of noise. The unit has a lower height than a standard duct unit, making it possible to install it in a small suspended ceiling space. The air conditioner automatically adjusts the static pressure and maintains a constant airflow.

**A<sup>+</sup>** | **R32**





## Features of **Kaisai KTI**



Double sided installation



Refrigerant leakage indication



Cold air control



Emergency use



Self-diagnosis



Timer



Automatic restart



Alarm port



Remote control temperature sensor



Electronic expansion valve



Operation at low outside temperatures



Twin combination



Fresh air



On-off port



Temperature compensation



Built-in condensate pump



Compressor and condensate tray heaters

**OPTIONAL**



Central controller

**OPTIONAL**



Wi-Fi control

## Technical specification

| MODEL                              | indoor unit     |                  | KTI-18HWG32X     | KTI-24HWG32X     | KTI-36HWG32X    | KTI-36HWG32X     | KTI-48HWG32X     | KTI-55HWG32X     |
|------------------------------------|-----------------|------------------|------------------|------------------|-----------------|------------------|------------------|------------------|
|                                    | outdoor unit    |                  | KOX330-18HF-N32X | KOX430-24HF-N32X | KOD30U-36HFJ32X | KOD30U-36HF-N32X | KOE30U-48HF-N32X | KOE30U-55HF-N32X |
| Capacity average (min÷max)         | cooling         | kW               | 5,3 (2,6÷5,9)    | 7,0 (3,3÷8,2)    | 10,6 (2,8÷11,1) | 10,6 (2,7÷11,8)  | 14,1 (3,5÷15,5)  | 15,2 (4,1÷17,3)  |
|                                    | heating         | kW               | 5,6 (2,2÷6,2)    | 7,6 (2,8÷8,5)    | 11,7 (2,8÷12,8) | 11,7 (2,8÷12,8)  | 16,1 (4,1÷18,2)  | 18,2 (4,4÷20,5)  |
| Energy class                       | cooling/heating |                  | A++/A+           | A++/A+           | A++/A+          | A++/A+           | A++/A+           | A++/A+           |
| SEER                               | average         | W/W              | 6,5              | 6,2              | 6,2             | 6,1              | 6,1              | 6,1              |
| SCOP                               | average         | W/W              | 4,0              | 4,0              | 4,0             | 4,0              | 4,0              | 4,0              |
| Avg. power consumption (min÷max)   | cooling         | W                | 1530 (710÷2150)  | 2190 (750÷2960)  | 3950 (900÷4150) | 4000 (890÷4200)  | 4800 (880÷6000)  | 5250 (1030÷6650) |
|                                    | heating         | W                | 1510 (740÷1760)  | 1900 (640÷2580)  | 3250 (800÷3950) | 3250 (780÷4000)  | 4500 (950÷5700)  | 5150 (950÷6600)  |
| Avg. operating current (min÷max)   | cooling         | A                | 7,1 (3,2÷9,6)    | 10,2 (4,2÷13,2)  | 17,5 (4,2÷18,5) | 6,5 (1,4÷6,7)    | 8,4 (1,9÷10,4)   | 9,6 (3,1÷11,5)   |
|                                    | heating         | A                | 6,8 (3,3÷7,7)    | 9,2 (3,8÷11,6)   | 14,5 (3,5÷17,5) | 5,3 (1,3÷6,4)    | 8,0 (2,0÷9,8)    | 9,5 (2,0÷11,5)   |
| Air flow rate                      | cooling         | m³/h             | 911/706/515      | 1229/1035/825    | 2100/1800/1500  | 2100/1800/1500   | 2400/2040/1680   | 2600/2210/1820   |
|                                    | heating         | m³/h             | 2200             | 3500             | 4000            | 4000             | 7500             | 7500             |
| Available compression ratio        |                 | Pa               | 25/100           | 25/160           | 37/160          | 37/160           | 50/160           | 50/160           |
| Operating temp. cooling/heating    | indoor          | °C               | 16÷32/0÷30       | 16÷32/0÷30       | 16÷32/0÷30      | 16÷32/0÷30       | 16÷32/0÷30       | 16÷32/0÷30       |
|                                    | outdoor         | °C               | -15+50/-15+24    | -15+50/-15+24    | -15+50/-15+24   | -15+50/-15+24    | -15+50/-15+24    | -15+50/-15+24    |
| Sound pressure level               | indoor          | dB(A)            | 41/38/34/26      | 42/40/37/27      | 49,5/48/46/42   | 49,5/48/46/42    | 50/49/47/42      | 52,5/49/47/42    |
|                                    | outdoor         | dB(A)            | 56               | 60               | 63              | 63               | 63,5             | 64               |
| Net dimensions w/h/d               | indoor          | mm               | 880/210/674      | 1100/249/774     | 1360/249/774    | 1360/249/774     | 1200/300/874     | 1200/300/874     |
|                                    | outdoor         | mm               | 805/554/330      | 890/673/342      | 946/810/410     | 946/810/410      | 952/1333/415     | 952/1333/415     |
| Transp. dimensions w/h/d           | indoor          | mm               | 1070/280/725     | 1305/315/805     | 1570/330/805    | 1570/330/805     | 1405/365/915     | 1405/365/915     |
|                                    | outdoor         | mm               | 915/615/370      | 995/740/398      | 1090/885/500    | 1090/885/500     | 1095/1480/495    | 1095/1480/495    |
| Net weight                         | indoor          | kg               | 24,4             | 32,3             | 40,5            | 40,5             | 47,4             | 47,6             |
|                                    | outdoor         | kg               | 26,6             | 43,9             | 66,9            | 80,5             | 103,7            | 107,0            |
| Transport weight                   | indoor          | kg               | 29,6             | 39,1             | 48,2            | 48,2             | 55,8             | 56,1             |
|                                    | outdoor         | kg               | 29,0             | 46,9             | 71,5            | 85,0             | 118,3            | 121,2            |
| Pipe diameter: liquid/gas          |                 | mm               | 6,35/12,7        | 9,52/15,9        | 9,52/15,9       | 9,52/15,9        | 9,52/15,9        | 9,52/15,9        |
| Maximum installation length        |                 | m                | 30               | 50               | 75              | 75               | 75               | 75               |
| Maximum height difference          |                 | m                | 20               | 25               | 30              | 30               | 30               | 30               |
| Power supply                       | outdoor         | V/Hz/Ph          | 220÷240/50/1     | 220÷240/50/1     | 220÷240/50/1    | 380÷420/50/3     | 380÷420/50/3     | 380÷420/50/3     |
| Circuit breaker/fuse               | outdoor         | A                | 16               | 20               | 25              | 16               | 16               | 16               |
| Power supply lines                 | outdoor         | # of wires x mm² | 3x2,5            | 3x2,5            | 3x4,0           | 5x2,5            | 5x2,5            | 5x2,5            |
| Control lines                      | ind. - outd.    |                  | 4x1,5            | 4x1,5            | 4x1,5           | 4x1,5            | 4x1,5            | 4x1,5            |
| Factory amount of refrigerant      | up to 5 rm      | kg               | 1,15             | 1,5              | 2,4             | 2,4              | 2,9              | 3,0              |
| Additional refrigerant             | over 5 rm       | g/m              | 12               | 24               | 24              | 24               | 24               | 24               |
| Outer diameter of condensate drain |                 | mm               | 25               | 25               | 25              | 25               | 25               | 25               |

## Controllers

WIRED REMOTE CONTROL



**KJR-120X2**

WIRELESS REMOTE CONTROL



**RG10A (OPTIONAL)**

WIRED REMOTE CONTROL



**KJR12B (OPTIONAL)**

WIRED REMOTE CONTROL



**KJR-120N (OPTIONAL)**

WIRED REMOTE CONTROL



**CCM (OPTIONAL)**







# condensing units

**Inverter condensing units are equipped with a control module, which enables connection of a universal outdoor unit to the freon exchanger in the air handling unit.**

This solution makes it possible to control the capacity of the condensing unit by means of a 0-10 V signal sent from the automation of the air handling unit. Both cooling and heating operation is possible. The units have built-in expansion valves, so no additional refrigeration fittings are required. Kaisai condensing units can only be used with air-handling units equipped with safety features due to the flammable properties of the R32 refrigerant.





## Technical specification

| MODEL                               |                 |                   | KOX230-12HFN32X | KOX330-18HFN32X | KOX430-24HFN32X |
|-------------------------------------|-----------------|-------------------|-----------------|-----------------|-----------------|
| Capacity average (min÷max)          | cooling         | kW                | 3,5(0,8÷4,1)    | 5,3(2,7÷5,9)    | 7,0(3,2÷7,8)    |
|                                     | heating         | kW                | 3,8(0,5÷4,3)    | 5,6(2,4÷6,3)    | 7,6(2,7÷8,3)    |
| Energy class                        | cooling/heating |                   | A++/A+          | A++/A+          | A++/A+          |
| SEER                                | średni          | W/W               | 6,6             | 6,2             | 6,1             |
| SCOP                                | średni          | W/W               | 4,1             | 4,0             | 4,0             |
| Average power consumption (min÷max) | cooling         | W                 | 1010(168÷1434)  | 1450(670÷2027)  | 2300(747÷2930)  |
|                                     | heating         | W                 | 1019(124÷1376)  | 1500(540÷1640)  | 2050(650÷2850)  |
| Average operating current (min÷max) | cooling         | A                 | 4,4(1,3÷6,3)    | 6,0(3,2÷9,0)    | 10,5(3,9÷13,1)  |
|                                     | heating         | A                 | 4,7(1,0÷6,1)    | 6,6(2,7÷7,3)    | 9,5(3,5÷12,7)   |
| Air flow rate                       |                 | m <sup>3</sup> /h | 2100            | 2200            | 3500            |
| Operating temperature               | cooling         | °C                | -15÷50/-15÷24   | -15÷50/-15÷24   | -15÷50/-15÷24   |
| Sound pressure level                |                 | dB(A)             | 53,6            | 56              | 60              |
| Net dimensions w/h/d                |                 | mm                | 765/555/303     | 805/554/330     | 890/673/342     |
| Transport dimensions w/h/d          |                 | mm                | 887/610/337     | 915/615/370     | 995/740/398     |
| Net weight                          |                 | kg                | 26,6            | 26,6            | 43,9            |
| Transport weight                    |                 | kg                | 29,0            | 29,0            | 46,9            |
| Pipe diameter: liquid/gas           |                 | mm                | 6,35/9,52       | 6,35/12,7       | 9,52/15,9       |
| Maximum installation length         |                 | m                 | 25              | 30              | 50              |
| Maximum height difference           |                 | m                 | 10              | 20              | 25              |
| Power supply                        |                 | V/Hz/Ph           | 220-240/50/1    | 220-240/50/1    | 220-240/50/1    |
| Circuit breaker/fuse                |                 | A                 | 16              | 16              | 20              |
| Power supply lines                  |                 | # of wires        | 3x2,5           | 3x2,5           | 3x2,5           |
| Control lines                       |                 | x mm <sup>2</sup> | 4x1,5           | 4x1,5           | 4x1,5           |
| Factory amount of refrigerant       | up to 5 rm      | kg                | 0,72            | 1,15            | 1,5             |
| Additional amount of refrigerant    | over 5 rm       | g/m               | 12              | 12              | 24              |

## Technical specification

| MODEL                               |                     |         | KOD30U-<br>-36HFJ32X | KOD30U-<br>-36HFN32X | KOE30U-<br>-48HFN32X | KOE30U-<br>-55HFN32X |
|-------------------------------------|---------------------|---------|----------------------|----------------------|----------------------|----------------------|
| Capacity average (min÷max)          | cooling             | kW      | 10,6(2,7÷11,4)       | 10,6(2,7÷11,8)       | 14,1(3,5÷15,2)       | 15,8(4,1÷16,7)       |
|                                     | heating             | kW      | 11,7(2,8÷12,8)       | 11,7(2,8÷12,8)       | 16,1(4,1÷17,0)       | 18,2(4,4÷19,6)       |
| Energy class                        | cooling/heating     |         | A++/A+               | A++/A+               | A++/A+               | A++/A+               |
| SEER                                | średni              | W/W     | 6,2                  | 6,4                  | 6,1                  | 6,1                  |
| SCOP                                | średni              | W/W     | 4,0                  | 4,1                  | 4,0                  | 4,0                  |
| Average power consumption (min÷max) | cooling             | W       | 3900(900÷4250)       | 40000(890÷4300)      | 5000(900÷5950)       | 5650(1100÷6650)      |
|                                     | heating             | W       | 3350(800÷3950)       | 3350(780÷3950)       | 5100(1000÷6050)      | 6050(1050÷7100)      |
| Average operating current (min÷max) | cooling             | A       | 17,0(4,2÷19,0)       | 6,3(1,4÷6,8)         | 8,8(1,9÷10,3)        | 9,7(3,2÷11,5)        |
|                                     | heating             | A       | 15,0(3,5÷17,5)       | 5,4(1,3÷6,2)         | 8,9(2,1÷10,5)        | 10,5(2,2÷12,0)       |
| Air flow rate                       |                     | m³/h    | 4000                 | 4000                 | 7500                 | 7500                 |
| Operating temperature               | cooling             | °C      | -15+50/-15+24        | -15+50/-15+24        | -15+50/-15+24        | -15+50/-15+24        |
| Sound pressure level                |                     | dB(A)   | 63                   | 63                   | 63,5                 | 64                   |
| Net dimensions w/h/d                |                     | mm      | 946/810/410          | 946/810/410          | 952/1333/415         | 952/1333/415         |
| Transport dimensions w/h/d          |                     | mm      | 1090/885/500         | 1090/885/500         | 1095/1480/495        | 1095/1480/495        |
| Net weight                          |                     | kg      | 66,9                 | 80,5                 | 103,7                | 107,0                |
| Transport weight                    |                     | kg      | 71,5                 | 85,0                 | 118,3                | 121,2                |
| Pipe diameter: liquid/gas           |                     | mm      | 9,52/15,9            | 9,52/15,9            | 9,52/15,9            | 9,52/15,9            |
| Maximum installation length         |                     | m       | 75                   | 75                   | 75                   | 75                   |
| Maximum height difference           |                     | m       | 30                   | 30                   | 30                   | 30                   |
| Power supply                        |                     | V/Hz/Ph | 220-240/50/1         | 380-420/50/3         | 380-420/50/3         | 380-420/50/3         |
| Circuit breaker/fuse                |                     | A       | 25                   | 16                   | 16                   | 16                   |
| Power supply lines                  | # of wires<br>x mm² |         | 3x4,0                | 5x2,5                | 5x2,5                | 5x2,5                |
| Control lines                       |                     |         | 4x1,5                | 4x1,5                | 4x1,5                | 4x1,5                |
| Factory amount of refrigerant       | up to 5 rm          | kg      | 2,4                  | 2,4                  | 2,9                  | 3,0                  |
| Additional amount of refrigerant    | over 5 rm           | g/m     | 24                   | 24                   | 24                   | 24                   |

## Generator types and controllers



KOX230-12HFN32X  
KOX330-18HFN32X  
KOX430-24HFN32X  
KOD30U-36HFJ32X  
KOD30U-36HFN32X



KOE30U 48 | 55 HFN32X



Control Module  
KMS-8142

# Portable air conditioners

**Portable air conditioners are perfect for places where you need to relocate or where stationary air conditioning is not possible.**

KPPH air conditioners with a cooling capacity of 2.6 kW have cooling, dehumidification and condensate evaporation functions. It is the perfect solution for rooms with low heat loads, up to approx. 20 m<sup>2</sup>. The KPPD model with a cooling capacity of 3.5 kW has an additional heating function and can also be used in larger rooms up to approx. 30 m<sup>2</sup>.





### Technical specification

| MODEL                      |                 | KPPH-09HRG29      |              |
|----------------------------|-----------------|-------------------|--------------|
| Capacity                   | cooling         | kW                | 2,6          |
|                            | heating         | kW                | -            |
| Energy class               | cooling/heating |                   | A            |
| EER                        | average         | W/W               | 2,6          |
| COP                        |                 |                   | -            |
| Power consumption          | cooling         | W                 | 1000         |
|                            | heating         | W                 | -            |
| Operating current          | cooling         | A                 | 4,4          |
|                            | heating         | A                 | -            |
| Air flow rate              |                 | m <sup>3</sup> /h | 295/195      |
| Operating temperature      |                 | °C                | 17÷35        |
| Sound pressure level       |                 | dB(A)             | 52/47,5      |
| Net dimensions w/h/d       |                 | mm                | 355/703/345  |
| Transport dimensions w/h/d |                 | mm                | 400/870/370  |
| Net weight                 |                 | kg                | 24,7         |
| Transport weight           |                 | kg                | 27,3         |
| Electric power supply      |                 | V/Hz/Ph           | 220÷240/50/1 |
| Refrigerant                |                 |                   | R290         |
| The amount of refrigerant  |                 | kg                | 0,17         |
| Moisture removal rate      |                 | l/h               | 2,3          |

### Controllers

WIRELESS  
REMOTE CONTROL



**RG51**

# Everything is always under control

## CONTROLLERS

WIRELESS  
REMOTE CONTROL

### RG10A4

**Controller dedicated for wall-mounted air conditioners**

Basic functions: On/off | Operating mode | Air temperature | Fan speed | Timer | Remote control temperature sensor | Automatic blinds | Air direction | Turbo | Self-cleaning of evaporator | Sustained heating at 8°C | Eco



WIRED  
CONTROLLER

### KJR-120X2

**Standard controller for duct air conditioners and optional controller for ICE, PRO HEAT wall, cassette and floor/ceiling air conditioners.**

Basic functions: On/off | Operating mode | Air temperature | Fan speed | Timer | Weekly programmer / Temperature sensor in remote control



WIRED  
CONTROLLER

### KJR12B

**Optional controller for wall-mounted and compact cassette air conditioners.**

Basic functions: On/off | Operating mode | Air temperature | Fan speed | Timer | Temperature sensor in remote control | Auto blinds



PILOT  
BEZPRZEWODOWY  
**RG10B, RG10B1**

**Controller dedicated for wall and floor mounted air conditioners**

Basic functions: On/off | Operating mode | Air temperature | Fan speed | Timer | Remote control temperature sensor | Automatic blinds | Air direction | Turbo | Self-cleaning of evaporator | Sustained heating at 8°C | Eco



WIRELESS  
REMOTE CONTROL  
**RG10N2**

**Controller dedicated for super slim cassette air conditioners.**

Basic functions: On/Off | Operating mode | Air temperature | Fan speed | Timer | VANE function | Clock | ECO function | GEAR function | Breeze away function | Temperature sensor on remote control



WIRELESS  
REMOTE CONTROL  
**RG10A, RG10A1**

**Controller dedicated for compact cassette, floor/ceiling, console and wall-mounted air conditioners from ICE and PROHEAT series.**

Basic functions: On/off | Operating mode | Air temperature | Fan speed | Timer | Remote control temperature sensor | Automatic blinds | Air direction | ECO | Ioniser | Sustained heating at 8°C



WIRELESS  
REMOTE CONTROL  
**RG51**

**Controller dedicated for KPPD and KPPH portable air conditioners and optional for wall, cassette and floor/ceiling units.**

Basic functions: On/off | Operating mode | Air temperature | Fan speed | Timer | Air direction | Auto blinds | Turbo



WIRED  
CONTROLLER  
**KJR-120N**

**Standard controller for duct air conditioners and optional controller for ICE, PRO HEAT wall, cassette and floor/ceiling air conditioners.**

Basic functions: On/off | Operating mode | Air temperature | Fan speed | Timer | Weekly programmer / Temperature sensor in remote control



WIRED  
CONTROLLER  
**CCM**

**Optional controller for cassette, floor/ceiling, wall-mounted ICE, PRO HEAT and duct air conditioners.**

Control up to 64 indoor units. In addition to the standard functions, it has options for locking: operating mode, individual controls and central control buttons. The maximum length of communication cables is 1200 m.

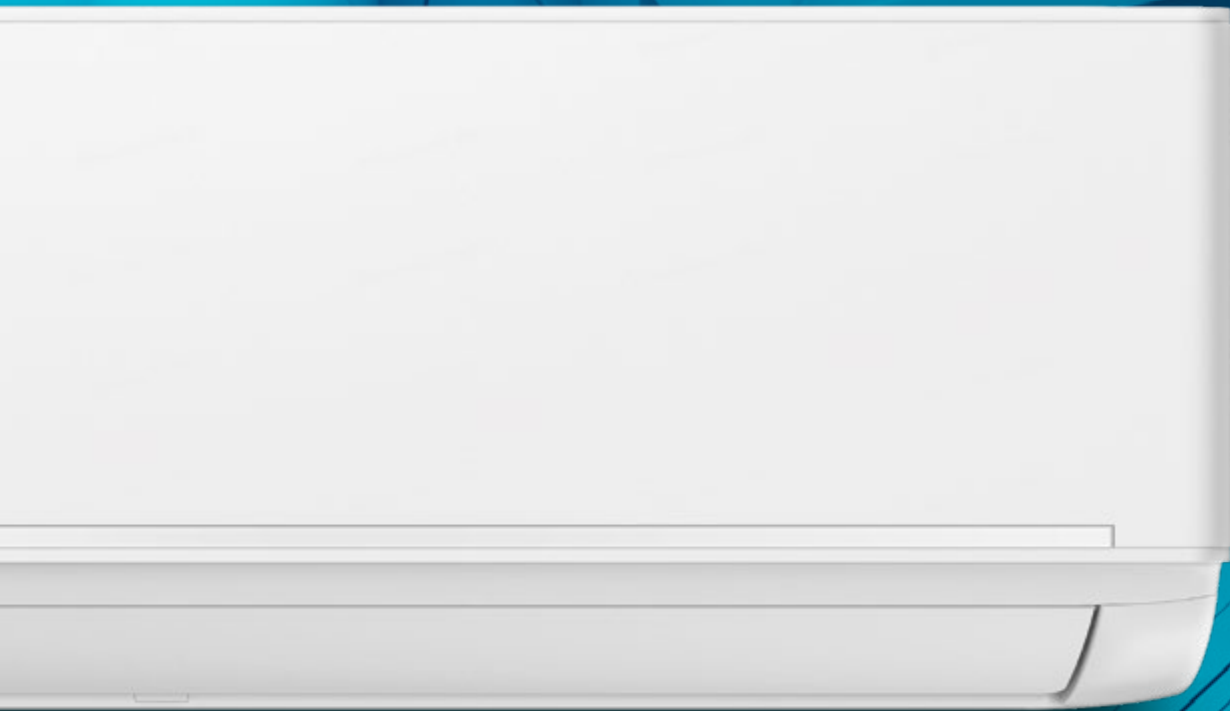



# Dimensions of the units

**The compact size of Kaisai units provides a sleek look and convenience while maintaining high performance and ease of installation.**

Kaisai air conditioners are energy efficient and easy to use units that require little space and provide the ideal room temperature in a very short time. All Kaisai air conditioners use environmentally friendly refrigerant and standard equipment includes Wi-Fi functionality for control using mobile devices. A number of practical functions ensuring optimal adjustment of the device to the needs of the user and a high level of comfort are available, depending on the model.

# Dimensions

## SPLIT UNITS

### WALL FLY

| MODEL      | DIMENSIONS [mm] |     |     |
|------------|-----------------|-----|-----|
|            | W               | D   | H   |
| KWX-09KRHI | 715             | 194 | 285 |
| KWX-12KRHI | 805             | 194 | 285 |
| KWX-18KRHI | 957             | 213 | 302 |
| KWX-24KRHI | 1040            | 220 | 327 |

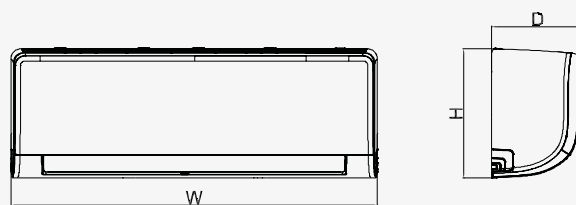
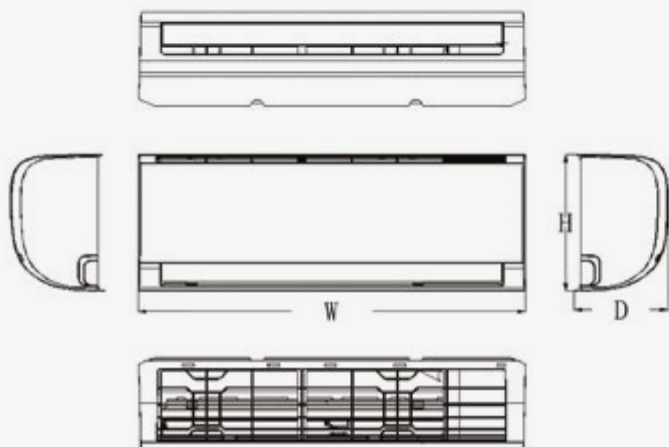

### WALL ICE

| MODEL      | DIMENSIONS [mm] |     |     |
|------------|-----------------|-----|-----|
|            | W               | D   | H   |
| KLW-09HRHI | 835             | 208 | 295 |
| KLB-09HRHI | 835             | 208 | 295 |
| KLW-12HRHI | 835             | 208 | 295 |
| KLB-12HRHI | 835             | 208 | 295 |
| KLW-18HRHI | 969             | 241 | 320 |
| KLB-18HRHI | 969             | 241 | 320 |
| KLW-24HRHI | 1083            | 244 | 336 |
| KLB-24HRHI | 1083            | 244 | 336 |

### WALL PRO HEAT

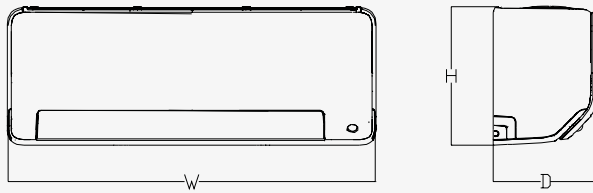

| MODEL      | DIMENSIONS [mm] |     |     |
|------------|-----------------|-----|-----|
|            | W               | D   | H   |
| KRP-09MEHI | 795             | 225 | 295 |
| KRP-12MEHI | 795             | 225 | 295 |
| KRP-18MEHI | 965             | 239 | 319 |
| KRP-24MEHI | 1140            | 275 | 370 |

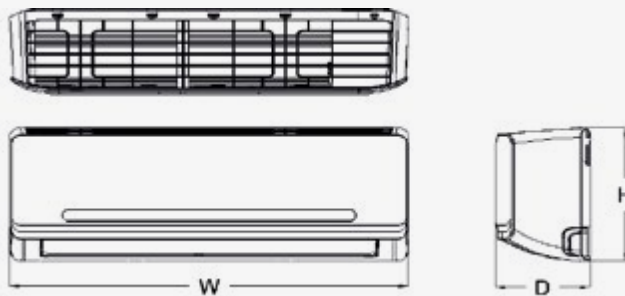

### WALL GEO

| MODEL      | DIMENSIONS [mm] |     |     |
|------------|-----------------|-----|-----|
|            | W               | D   | H   |
| KGE-09GRHI | 802             | 189 | 297 |
| KGE-12GRHI | 802             | 189 | 297 |
| KGE-18GRHI | 965             | 215 | 319 |
| KGE-24GRHI | 1080            | 226 | 335 |

### FLOOR AND CEILING

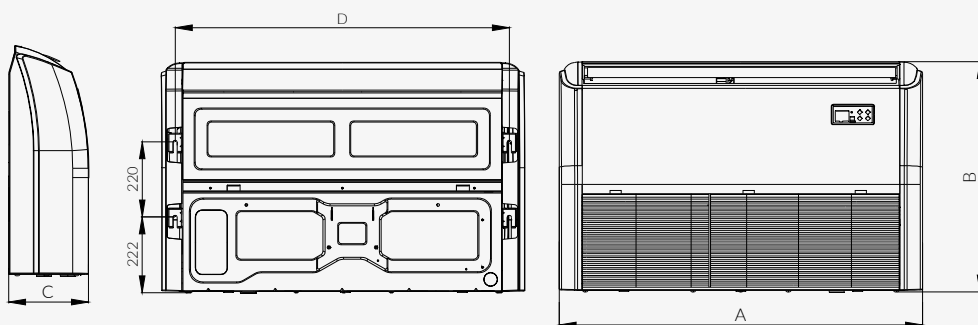

| MODEL        | DIMENSIONS [mm] |     |     |      |
|--------------|-----------------|-----|-----|------|
|              | A               | B   | C   | D    |
| KUE-18HRG32X | 1068            | 675 | 235 | 983  |
| KUE-24HRG32X | 1068            | 675 | 235 | 983  |
| KUE-36HRG32X | 1650            | 675 | 235 | 1565 |
| KUE-48HRG32X | 1650            | 675 | 235 | 1565 |
| KUE-55HRG32X | 1650            | 675 | 235 | 1565 |

## CONSOLE

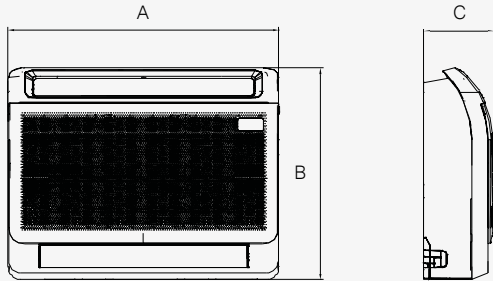

| MODEL         | DIMENSIONS [mm] |     |     |
|---------------|-----------------|-----|-----|
|               | A               | B   | C   |
| KFAU-12HRG32X | 794             | 621 | 200 |
| KFAU-17HRG32X | 794             | 621 | 200 |

## PORTABLE KPPH

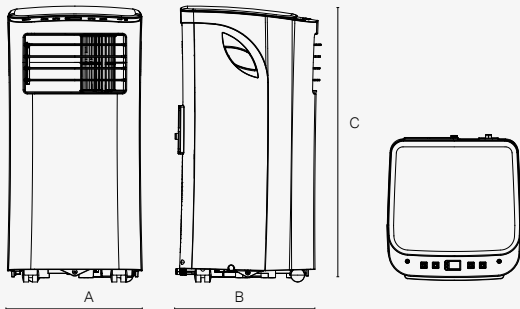

| MODEL        | DIMENSIONS [mm] |     |     |
|--------------|-----------------|-----|-----|
|              | A               | B   | C   |
| KPPH-09HRG29 | 355             | 345 | 703 |

## DUCT SLIM

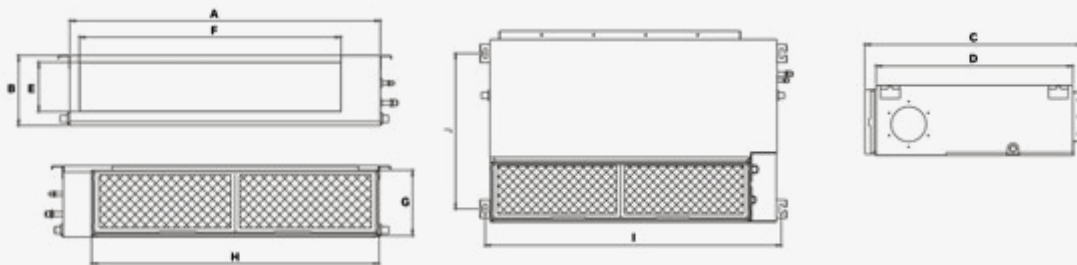

| MODEL                      | DIMENSIONS [mm] |     |     |     |     |      |     |      |      |     |
|----------------------------|-----------------|-----|-----|-----|-----|------|-----|------|------|-----|
|                            | A               | B   | C   | D   | E   | F    | G   | H    | I    | J   |
| KTI-18HWG32X               | 880             | 210 | 674 | 600 | 136 | 706  | 190 | 782  | 920  | 508 |
| KTI-24HWG32X               | 1100            | 249 | 774 | 700 | 175 | 926  | 228 | 1001 | 1140 | 598 |
| KTI-36 HWG32X              | 1360            | 249 | 774 | 700 | 175 | 1186 | 228 | 1261 | 1400 | 598 |
| KTI-48HWG32X, KTI-55HWG32X | 1200            | 300 | 874 | 800 | 227 | 1044 | 280 | 1101 | 1240 | 697 |

FLOOR

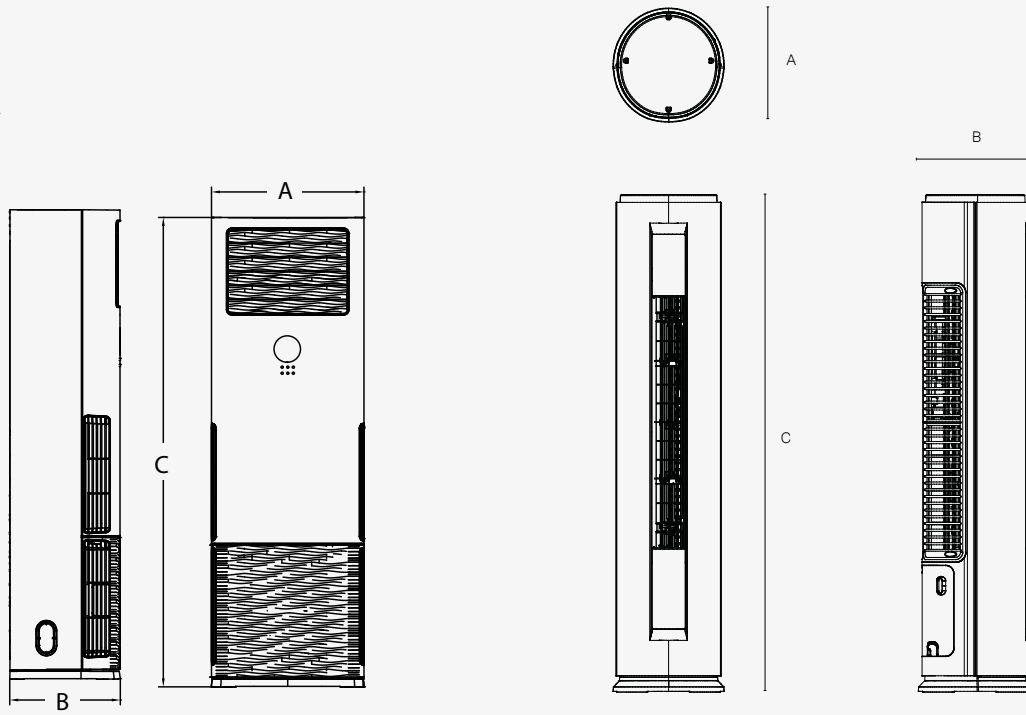

| MODEL        | DIMENSIONS [mm] |     |      |
|--------------|-----------------|-----|------|
|              | A               | B   | C    |
| KFS-48HRG32X | 629             | 456 | 1935 |

| MODEL        | DIMENSIONS [mm] |     |      |
|--------------|-----------------|-----|------|
|              | A               | B   | C    |
| KFS-24HRG32X | 405             | 405 | 1775 |

CASSETTE COMPACT

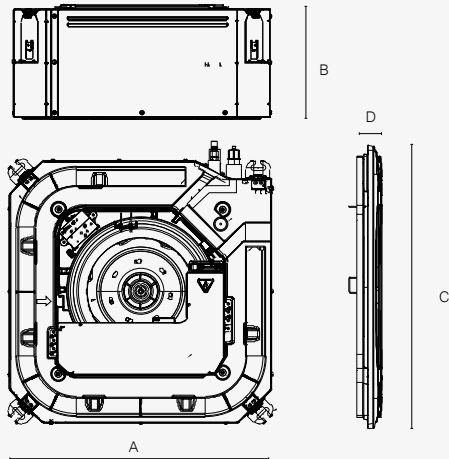

| MODEL          | DIMENSIONS [mm] |     |     |    |
|----------------|-----------------|-----|-----|----|
|                | A               | B   | C   | D  |
| KCA4U-12HRG32X | 570             | 245 | 620 | 50 |
| KCA4U-18HRG32X | 570             | 245 | 620 | 50 |

CASSETTE SUPER SLIM

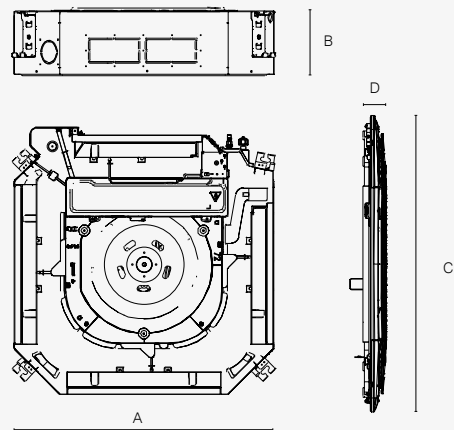

| MODEL        | DIMENSIONS [mm] |     |     |    |
|--------------|-----------------|-----|-----|----|
|              | A               | B   | C   | D  |
| KCD-24HRG32X | 830             | 205 | 950 | 55 |
| KCD-36HRG32X | 830             | 205 | 950 | 55 |
| KCD-48HRG32X | 830             | 205 | 950 | 55 |
| KCD-55HRG32X | 830             | 205 | 950 | 55 |

# Dimensions

## MULTI SPLIT APPLIANCES

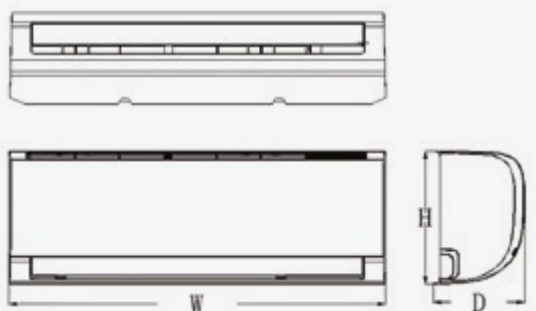

WALL FLY

| MODEL       | DIMENSIONS [mm] |     |     |
|-------------|-----------------|-----|-----|
|             | W               | D   | H   |
| KWX-09KKRHI | 715             | 194 | 285 |
| KWX-12KKRHI | 805             | 194 | 285 |
| KWX-18KKRHI | 957             | 213 | 302 |
| KWX-24KKRHI | 1040            | 220 | 327 |

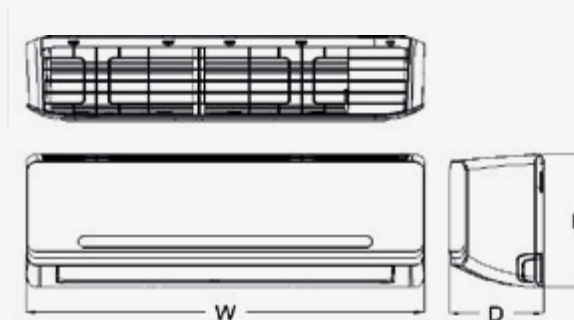

WALL GEO

| MODEL      | DIMENSIONS [mm] |     |     |
|------------|-----------------|-----|-----|
|            | W               | D   | H   |
| KGE-09GRHI | 802             | 189 | 297 |
| KGE-12GRHI | 802             | 189 | 297 |
| KGE-18GRHI | 965             | 215 | 319 |
| KGE-24GRHI | 1080            | 226 | 335 |

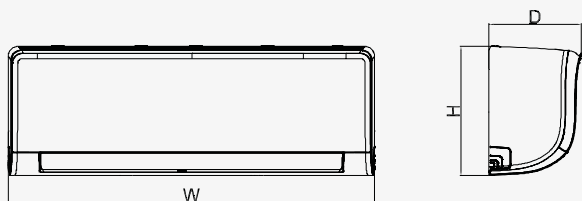

WALL ICE

| MODEL      | DIMENSIONS [mm] |     |     |
|------------|-----------------|-----|-----|
|            | W               | D   | H   |
| KLW-09HRHI | 835             | 208 | 295 |
| KLB-09HRHI | 835             | 208 | 295 |
| KLW-12HRHI | 835             | 208 | 295 |
| KLB-12HRHI | 835             | 208 | 295 |
| KLW-18HRHI | 969             | 241 | 320 |
| KLB-18HRHI | 969             | 241 | 320 |
| KLW-24HRHI | 1083            | 244 | 336 |
| KLB-24HRHI | 1083            | 244 | 336 |

### CASSETTE

| MODEL          | DIMENSIONS [mm] |     |     |    |
|----------------|-----------------|-----|-----|----|
|                | A               | B   | C   | D  |
| KCA4U-12HRG32X | 570             | 245 | 620 | 50 |
| KCA4U-18HRG32X | 570             | 245 | 620 | 50 |

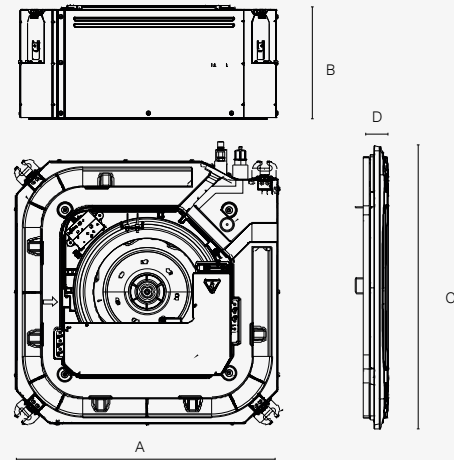

### CONSOLE

| MODEL         | DIMENSIONS [mm] |     |     |
|---------------|-----------------|-----|-----|
|               | A               | B   | C   |
| KFAU-12HRG32X | 794             | 621 | 200 |
| KFAU-17HRG32X | 794             | 621 | 200 |

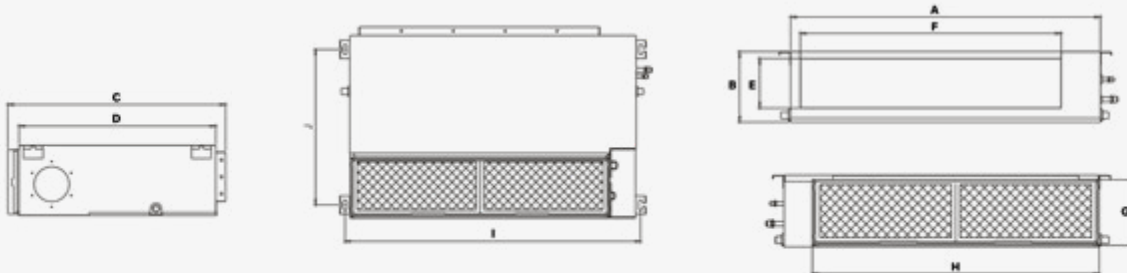
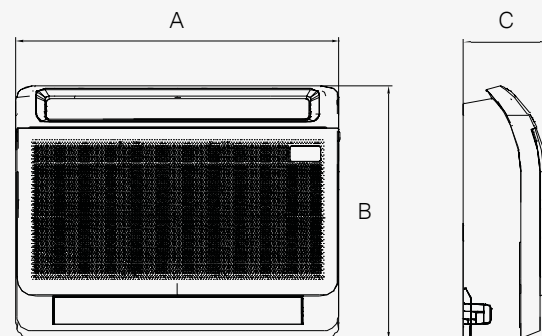

### DUCT

| MODEL        | DIMENSIONS [mm] |     |     |     |     |     |     |     |     |     |
|--------------|-----------------|-----|-----|-----|-----|-----|-----|-----|-----|-----|
|              | A               | B   | C   | D   | E   | F   | G   | H   | I   | J   |
| KTI-18HWG32X | 880             | 210 | 674 | 600 | 136 | 706 | 190 | 782 | 920 | 508 |

# Dimensions

## OUTDOOR UNITS

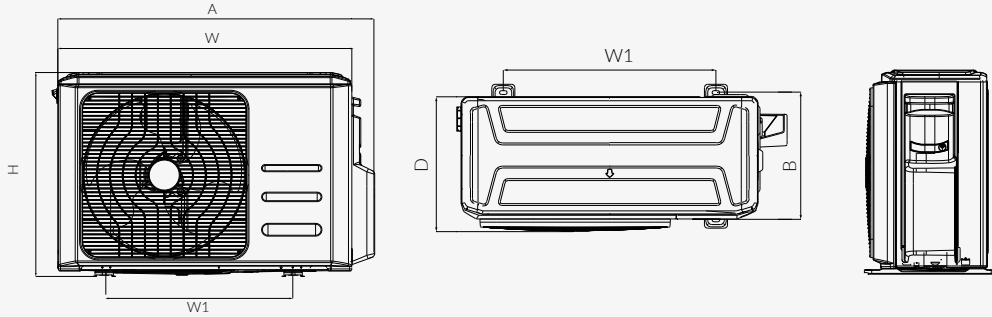

### FOR WALL UNITS

| MODEL       | DIMENSIONS [mm] |     |     |     |     |     |
|-------------|-----------------|-----|-----|-----|-----|-----|
|             | W               | D   | H   | W1  | A   | B   |
| KWX-09KRHO  | 720             | 270 | 495 | 452 | 790 | 255 |
| KWX-12KRHO  | 720             | 270 | 495 | 452 | 790 | 255 |
| KWX-18KRHO  | 805             | 330 | 554 | 511 | 874 | 317 |
| KWX-24KRHO  | 890             | 342 | 673 | 663 | 955 | 348 |
| KLWB-09HRHO | 765             | 303 | 555 | 452 | 835 | 286 |
| KLWB-12HRHO | 765             | 303 | 555 | 452 | 835 | 286 |
| KLWB-18HRHO | 805             | 330 | 554 | 511 | 874 | 317 |
| KLWB-24HRHO | 890             | 342 | 673 | 663 | 955 | 348 |
| KGE-09GRHO  | 765             | 303 | 555 | 452 | 835 | 286 |
| KGE-12GRHO  | 765             | 303 | 555 | 452 | 835 | 286 |
| KGE-18GRHO  | 805             | 330 | 554 | 511 | 874 | 317 |
| KGE-24GRHO  | 890             | 342 | 673 | 663 | 955 | 348 |
| KRP-09MEHO  | 805             | 330 | 554 | 511 | 874 | 317 |
| KRP-12MEHO  | 805             | 330 | 554 | 511 | 874 | 317 |
| KRP-18MEHO  | 890             | 342 | 673 | 663 | 955 | 348 |
| KRP-24MEHO  | 890             | 342 | 673 | 663 | 955 | 348 |

### FOR MULTI-SPLIT MODELS

| MODEL         | DIMENSIONS [mm] |     |     |     |      |     |
|---------------|-----------------|-----|-----|-----|------|-----|
|               | W               | D   | H   | W1  | A    | B   |
| K2OE-18HFN32H | 805             | 330 | 554 | 511 | 877  | 317 |
| K3OA-27HFN32H | 890             | 342 | 673 | 663 | 990  | 354 |
| K4OE-28HFN32H | 946             | 410 | 810 | 673 | 1034 | 403 |
| K4OB-36HFN32H | 946             | 410 | 810 | 673 | 1034 | 403 |
| K5OE-42HFN32H | 946             | 410 | 810 | 673 | 1034 | 403 |

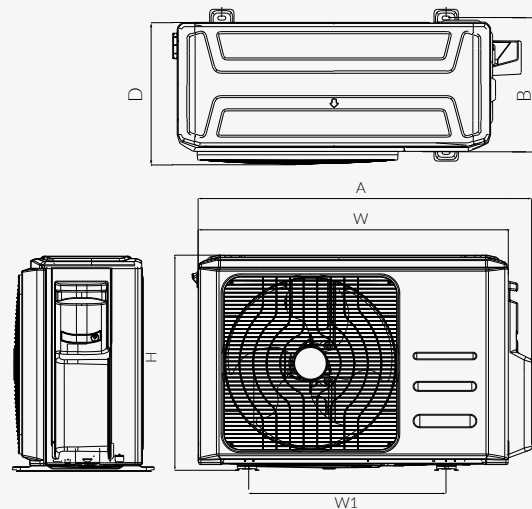



FOR CASSETTE, FLOOR, FLOOR/CEILING MOUNTED, CONSOLE AND DUCT MODELS

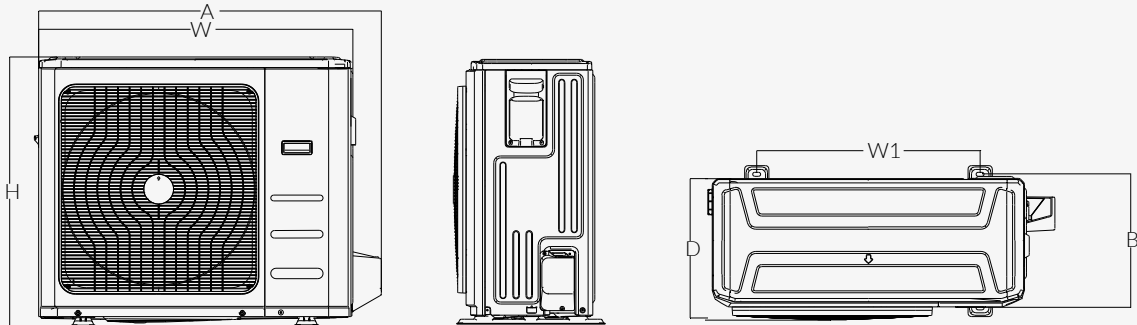

KOX230-12HFN32X, KOX330-18HFN32X, KOX430-24HFN32X, KOD30U-36HFJ32X, KOD30U-36HFN32X

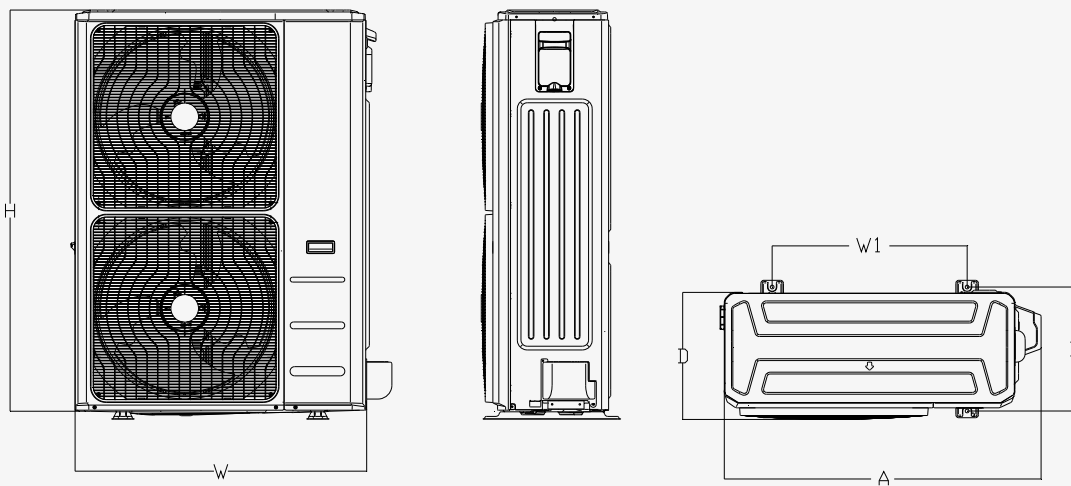

KOE30U-48HFN32X, KOE30U-55HFN32X

| MODEL            | DIMENSIONS [mm] |     |      |     |      |     |
|------------------|-----------------|-----|------|-----|------|-----|
|                  | W               | D   | H    | W1  | A    | B   |
| KOX230-12HFN32X  | 765             | 303 | 555  | 452 | 835  | 286 |
| KOX330-18HFN32X  | 805             | 330 | 554  | 511 | 874  | 317 |
| KOX430-24HFN32X  | 890             | 342 | 673  | 663 | 955  | 348 |
| KOX430L-24HFN32X | 890             | 342 | 673  | 663 | 955  | 348 |
| KOD30U-36HFJ32X  | 946             | 410 | 810  | 673 | 1030 | 403 |
| KOD30U-36HFN32X  | 946             | 410 | 810  | 673 | 1030 | 403 |
| KOE30U-48HFN32X  | 952             | 415 | 1333 | 634 | 1045 | 404 |
| KOE30U-55HFN32X  | 952             | 415 | 1333 | 634 | 1045 | 404 |

# Accessories



SEQUENTIAL  
CONTROLLER

## SPN-IR

**Applies to all split air conditioner models**

It is used to control the operation of 2 air conditioners (optionally 4) in an alternate manner. The controller communicates with air conditioners using an infra-red module (copies the signal from the wireless remote control).



SEQUENTIAL  
CONTROLLER

## TS4

**Applies to all split air conditioner models (except wall units)**

It is used to control the operation of 2 to 4 devices in the alternate mode. The TS4 controller replaces time switches and other complex electrical systems and communicates with air conditioners via a wired installation.



WINTER KITS

**FOR THE HEATING FUNCTION**  
**Applies to all split models**

The kit consists of compressor and drip tray heaters and a thermostat. It quickly removes snow and ice from the outdoor unit, ensuring trouble-free operation during winter.



**FOR THE COOLING FUNCTION**  
**Applies to all split models**

The kit consists of a compressor heater and a thermostat. Prevents absorption of refrigerant by oil.





CONTROL MODULE  
FOR AIR  
HANDLING UNIT

### KMS-8142

**Applies to condensing units  
with communication lines L,N,S**

The module allows the inverter condensing unit to be controlled by a 0-10 V DC signal from the air handling unit automation.



CONNECTION SET FOR WIRED  
REMOTE CONTROL

### ZPPP-FLY

**Applies to FLY air conditioners**

The kit allows you to connect a KJ-R-12B wired remote control to a Kaisai FLY series air conditioner.



EXTENSION MODULE

### MFB ICE/HOT, MFB PRO HEAT

**Applies to ICE, HOT, PRO HEAT air conditioners**

Enables connection of: KJ-R-120X2 wired controller, CCM central controller, Modbus gateway, ON/OFF control signal, alarm signal output

123



DIAGNOSTIC MODULE

### DR SMART

**Applies to all split air conditioner models**

The diagnostic module makes it possible to read the operating parameters of split air conditioners and facilitates their diagnosis and repair.

# Accessories



MODBUS GATE

## MD-AC-MBS1

**Applies to all split air conditioner models**

The gateway makes it possible to connect the air conditioner to the BMS central control system.

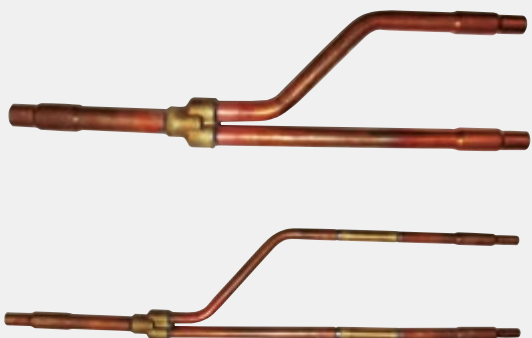

BRANCH PIPE

## UTP-SX236A

## UTP-SX354A

**For TWIN simultaneous system**

T-pieces are required for the cooling installation of the Twin simultaneous system.



WIFI MODULE

## OSK105

**Applies to wall-mounted air conditioners**

The module allows you to control your split air conditioner with your smartphone or tablet.



WIFI MODULE

## LCAC

**Applies to commercial air conditioners**

The module allows you to control your split air conditioner with your smartphone or tablet.

# Filters

## SILVER ION FILTER

The silver ion filter is responsible for destroying bacteria and preventing the growth of micro-organisms such as viruses and fungi. The internal structure of the silver ions destroys micro-organisms.

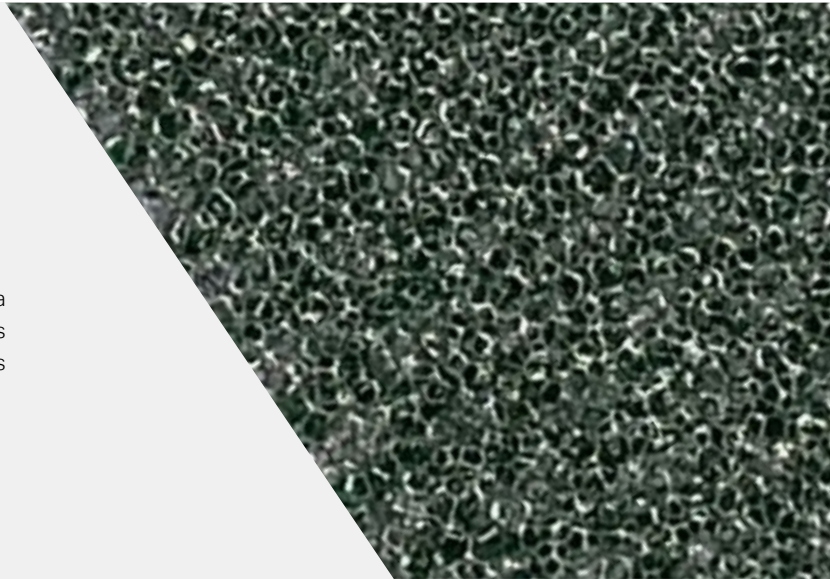

## BIOHEPA FILTER

The air purification function is further supported by the Bio HEPA filter, which effectively traps 99% of dust particles and bacteria with a size of 0.3 µm and up to 95% of particles from 0.1 to 0.3 µm, including fungal cells and some viruses



## VITAMIN C FILTER

The filter emits vitamin C, which has a positive effect on the skin by protecting it from the sun's rays. Being an active antioxidant agent, vitamin C has a nourishing effect, stimulates collagen production and reduces stress.



## 3M FILTER

Thanks to its unique design, the filter captures dust particles and other harmful substances from the air, which can cause many respiratory diseases.



## COLD CATALYTIC FILTER

The cold-catalytic filter eliminates chemicals such as carbon monoxide, hydrogen sulphide, ammonia, benzene and formaldehyde

# KAISAI

AIR CONDITIONING | HEATING  
VENTILATION | PHOTOVOLTAICS

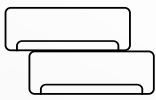

AIR  
CONDITIONING

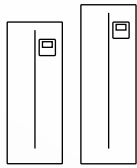

HEAT  
PUMPS

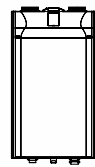

HEAT RECOVERY  
UNITS



PHOTOVOLTAIC  
MODULES AND INVERTERS



The full range of products is available on our website [kaisai.com](https://www.kaisai.com)

# Contact details

## FOR CONSUMERS:

Are you interested in buying our products?  
Check the current list of Distributors in Poland at: [www.kaisai.com](http://www.kaisai.com)

---

## FOR DISTRIBUTORS AND INSTALLERS:

### HEAD OFFICE

ul. Ostrobramska 101A  
04-041 Warsaw  
22 517 36 00 | 22 879 99 07

### SALES DEPARTMENT

22 465 65 85  
[handlowy@kaisai.com](mailto:handlowy@kaisai.com)

**Do you want to become our Distributor? Write or call us.**

---

## KLIMA-THERM GROUP ACADEMY:

### GDAŃSK BRANCH

ul. Budowlanych 48  
80-298 Gdańsk  
58 768 03 33

### WARSAW BRANCH

ul. Ostobramska 101A  
04-041 Warsaw  
22 517 36 00

### KATOWICE BRANCH

ul. Chorzowska 108, Budynek B  
40-101 Katowice  
32 209 49 26

**Do you want to obtain an authorisation certificate and become our Installer?**

Contact us: [handlowy@kaisai.com](mailto:handlowy@kaisai.com)

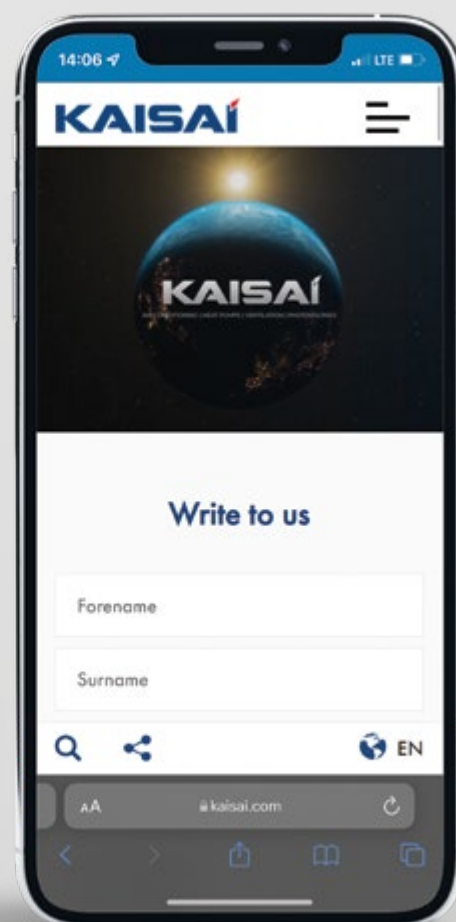

This document is for information and demonstration of Kaisai brand air conditioners. Since the technologically advanced production process necessitates its continuous control and improvement, the information contained in this publication may be subject to change. | Specifications shown in the catalogue are subject to change. Up-to-date information is always available on the website: [www.kaisai.com](http://www.kaisai.com)



**[kaisai.com](http://kaisai.com)**